

PM3C20-00030000

Mirror

REFLECTORS AND OPTICS

SICK
Sensor Intelligence.



Ordering information

Type	part no.
PM3C20-00030000	1043456

Other models and accessories → www.sick.com/Mirror

Detailed technical data

Features

Description	PM3C mirror column with fixed mirror for beam deflection. Allows multi-sided access protection.
Mounting system type	Mechanical anchoring to the floor
Items supplied	PM3C mirror column with pre-assembled base plate
Column height	2,216.5 mm
Mirror height	1,832 mm
Mirror width	125 mm
Suitable for device variants	
deTec safety light curtain	Protective field height ≤ 1,800 mm
C2000, C4000, M4000 Curtain safety light curtain	Protective field height ≤ 1,800 mm
deTem safety light-beam sensor	Any
M2000, M4000 safety light-beam sensor	Any
Suitable for	Safety light curtains Safety light-beam sensors
Type of diversion	Horizontal

Mechanics

Dimensions	See dimensional drawing
L1	1,832 mm ¹⁾
L2	345 mm ²⁾
L5	2,216.5 mm ³⁾
Cross-section of column profile	148 mm x 118 mm
Diameter of base plate	180 mm
Weight	15.43 kg

¹⁾ L1 = Mirror height.

²⁾ L2 = Distance of bottom end of mirror from floor.

³⁾ L5 = Column height (incl. base plate).

Classifications

ECLASS 5.0	27279207
ECLASS 5.1.4	27279207
ECLASS 6.0	27279207
ECLASS 6.2	27279207
ECLASS 7.0	27279207
ECLASS 8.0	27279207
ECLASS 8.1	27279207
ECLASS 9.0	27273605
ECLASS 10.0	27273605
ECLASS 11.0	27273605
ECLASS 12.0	27273605
ETIM 5.0	EC002467
ETIM 6.0	EC002467
ETIM 7.0	EC002467
ETIM 8.0	EC002467
UNSPSC 16.0901	39111609

Dimensional drawing PM3

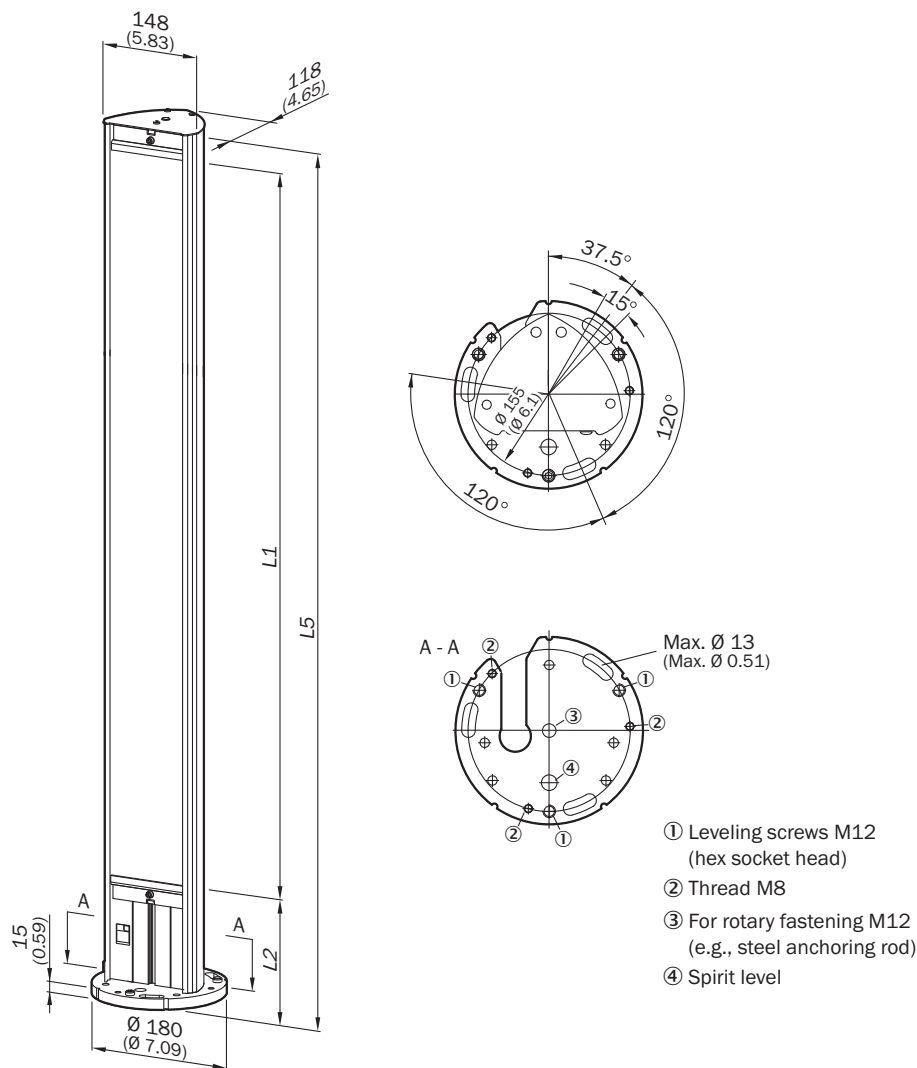

Dimensions in mm (inch)

- ① leveling screws M12 (hex socket head)
- ② thread M8
- ③ for rotary fastening M12 (e.g., steel anchoring rod)
- ④ spirit level

Type	Part no.	L1 = Mirror height	L2 = Distance of bottom end of mirror from floor	L5 = Column height (incl. base plate)	Suitable for protective field height
PM3C13-00030000	1043453	1.082	160	1.281,5	≤ 1.050
PM3C15-00030000	1077525	1.382	145	1.569	≤ 1.350
PM3C17-00030000	1043454	1.532	145	1.716,5	≤ 1.500
PM3C19-00030000	1043455	1.682	295	2.016,5	≤ 1.650
PM3C20-00030000	1043456	1.832	345	2.216,5	≤ 1.800
PM3C22-00030000	1093216	1.982	245	2.269	≤ 1.950
PM3C24-00030000	1093217	2.132	245	2.419	≤ 2.100

SICK AT A GLANCE

SICK is one of the leading manufacturers of intelligent sensors and sensor solutions for industrial applications. A unique range of products and services creates the perfect basis for controlling processes securely and efficiently, protecting individuals from accidents and preventing damage to the environment.

We have extensive experience in a wide range of industries and understand their processes and requirements. With intelligent sensors, we can deliver exactly what our customers need. In application centers in Europe, Asia and North America, system solutions are tested and optimized in accordance with customer specifications. All this makes us a reliable supplier and development partner.

Comprehensive services complete our offering: SICK LifeTime Services provide support throughout the machine life cycle and ensure safety and productivity.

For us, that is “Sensor Intelligence.”

WORLDWIDE PRESENCE:

Contacts and other locations –www.sick.com