



DT500-A111S02

Dx500

TIME-OF-FLIGHT SENSORS

SICK
Sensor Intelligence.



Ordering information

Type	part no.
DT500-A111S02	1042561

Other models and accessories → www.sick.com/Dx500



Detailed technical data

Features

Measuring range	0.2 m ... 30 m, 90% remission factor ^{1) 2)} 0.8 m ... 15 m, 6% remission factor ^{1) 2)}
Target	Natural objects
Resolution	12 bit
Repeatability	1 mm ^{3) 4)}
Measurement accuracy	± 3 mm
Response time	250 ms
Output time	250 ms
Emitted beam	
Light source	Laser, red ⁵⁾
Type of light	Visible red light
Typ. light spot size (distance)	10 mm (at 7 m)
	45 mm (at 30 m)
	100 mm (at 70 m)
Key laser figures	
Normative reference	IEC 60825-1:2014, EN 60825-1:2014
Laser class	2 ⁶⁾

¹⁾ In ambient light, max. 1 klx of constant light.

²⁾ Unique up to 150 m.

³⁾ 6% ... 90% remission factor.

⁴⁾ Statistical error 1 σ .

⁵⁾ Average service life of 50,000 h at $T_A = +25 \text{ }^\circ\text{C}$.

⁶⁾ Do not intentionally look into the laser beam. Never point the laser beam at people's eyes.

Interfaces

Analog output

¹⁾ Analog output_{PNP} active when the object is located inside the valid switching range.

²⁾ Laser-off input inverted, HIGH laser on.

³⁾ No external teach possible, only via pushbuttons.

	Number	1
	Type	Current output
	Current	0 mA ... 20 mA ¹⁾
Multifunctional input (MF)		PNP ^{2) 3)}
Laser-off input		Laser-off input inverted, HIGH laser on

¹⁾ Analog output_{PNP} active when the object is located inside the valid switching range.

²⁾ Laser-off input inverted, HIGH laser on.

³⁾ No external teach possible, only via pushbuttons.

Electronics

Supply voltage U_B	DC 10 V ... 30 V, reverse polarity protected $U_V \geq$ DC 24 V for devices with heating
Power consumption	Typ. 3 W
Ripple	5 V _{pp} ¹⁾
Initialization time	500 ms
Enclosure rating	IP65
Protection class	II ²⁾
Connection type	Male connector

¹⁾ May not fall short of or exceed V_S tolerances.

²⁾ Reference voltage DC 32 V.

Mechanics

Dimensions (W x H x D)	69 mm x 50 mm x 153 mm
Housing material	Metal (Aluminum die cast)
Window material	Glass
Weight	1,000 g

Ambient data

Ambient temperature, operation	-10 °C ... +45 °C -10 °C ... +75 °C, operation with cooling case
Ambient temperature, storage	-25 °C ... +75 °C
Temperature drift	Typ. 0.05 mm/K
Typ. Ambient light immunity	\leq 3,000 lx
Mechanical load	Shock: (EN 600 68-2-27 / -2-29) Sine: (EN 600 68-2-6) Noise: (EN 600 68-2-64)
Electromagnetic compatibility (EMC)	EN 61000-6-2 / EN 61000-6-3

Certificates

EU declaration of conformity	✓
UK declaration of conformity	✓
ACMA declaration of conformity	✓
Moroccan declaration of conformity	✓
China RoHS	✓

Classifications

ECLASS 5.0	27270801
ECLASS 5.1.4	27270801
ECLASS 6.0	27270801
ECLASS 6.2	27270801
ECLASS 7.0	27270801
ECLASS 8.0	27270801
ECLASS 8.1	27270801
ECLASS 9.0	27270801
ECLASS 10.0	27270801
ECLASS 11.0	27270801
ECLASS 12.0	27270916
ETIM 5.0	EC001825
ETIM 6.0	EC001825
ETIM 7.0	EC001825
ETIM 8.0	EC001825
UNSPSC 16.0901	411111613

Dimensional drawing

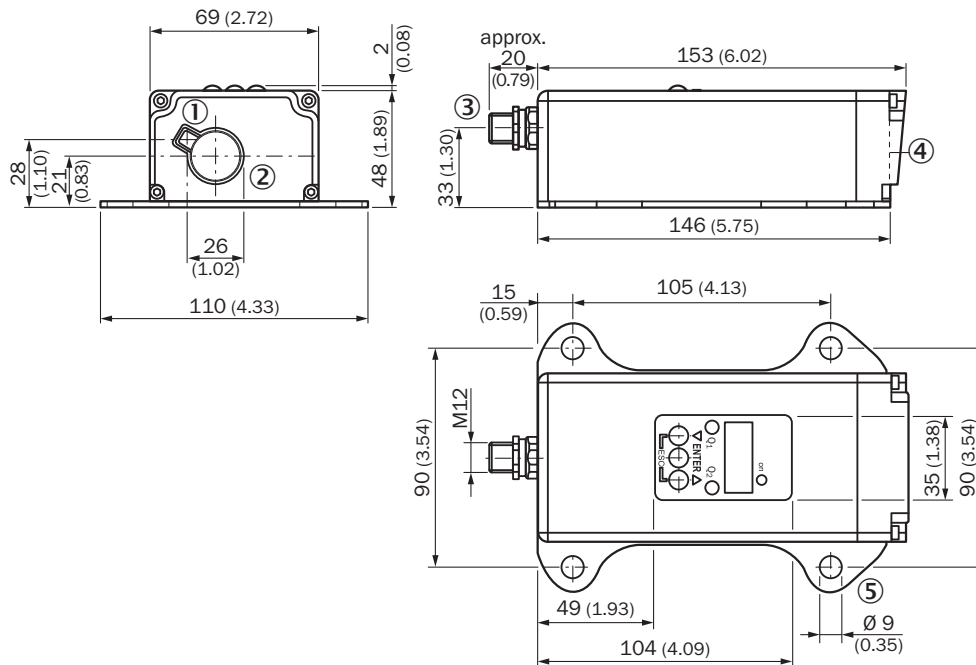

Dimensions in mm (inch)

- ① Optical axis, sender
- ② Optical axis, receiver
- ③ male connector M12, 8-pin
- ④ Zero level
- ⑤ fixing hole

Connection type DT500-Axx3 CAN (Layer 2) Connector M12, 8-pin

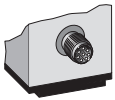

Connection diagram

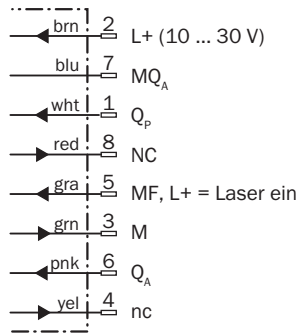

Adjustment possible

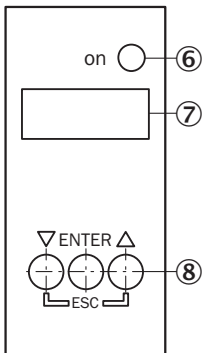

- ⑥ Operating indicator
- ⑦ Indicator panel, 7-segment display
- ⑧ Control panel

Additional information

Extern Teach ET via MF ①

Teach-in	MF active	Model
0 mA	100 ms	Current measurement value is used
4 mA	200 ms	
20 mA	300 ms	
Laser off	> 450 ms	

① Multi functional input.

Error performance or no object in measurement range

Measurement not possible

Measurement value output display	Analog interface	CAN Bus	Serial interface
0.000	0/3.5 mA	00000	00000 CRLF

No object in measurement range or laser off

Measurement value output display	Analog interface	CAN Bus	Serial interface
99.99	20.5 mA	99999	99999 CRLF







function MF input

Function MF input

Teach in	0 mA	60 ms < MF < 150 ms
Teach in	4 mA	150 ms < MF < 250 ms
Teach in	20 mA	250 ms < MF < 350 ms
Laser off	-	450 ms < MF < ∞

Recommended accessories

Other models and accessories → www.sick.com/Dx500

	Brief description	Type	part no.
connectors and cables			
	<ul style="list-style-type: none"> Description: Sensor/actuator cable, unshielded Connection type head A: Female connector, M12, 5-pin, straight, A-coded Connection type head B: Flying leads Signal type: Sensor/actuator cable Cable: 2 m, 5-wire, PVC Application: Uncontaminated zones, Zones with chemicals 	YF2A15-020VB5XLEAX	2096239
	<ul style="list-style-type: none"> Description: Sensor/actuator cable, unshielded Connection type head A: Female connector, M12, 5-pin, straight, A-coded Connection type head B: Flying leads Signal type: Sensor/actuator cable Cable: 5 m, 5-wire, PVC Application: Uncontaminated zones, Zones with chemicals 	YF2A15-050VB5XLEAX	2096240
	<ul style="list-style-type: none"> Description: Sensor/actuator cable, unshielded Connection type head A: Female connector, M12, 5-pin, straight, A-coded Connection type head B: Flying leads Signal type: Sensor/actuator cable Cable: 10 m, 5-wire, PVC Application: Uncontaminated zones, Zones with chemicals 	YF2A15-100VB5XLEAX	2096241
	<ul style="list-style-type: none"> Description: Sensor/actuator cable, unshielded Connection type head A: Female connector, M12, 5-pin, straight, A-coded Connection type head B: Flying leads Signal type: Sensor/actuator cable Cable: 0.6 m, 5-wire, PVC Application: Uncontaminated zones, Zones with chemicals 	YF2A15-C60VB5XLEAX	2145570
	<ul style="list-style-type: none"> Description: Sensor/actuator cable, unshielded Connection type head A: Female connector, M12, 5-pin, straight, A-coded Connection type head B: Flying leads Signal type: Sensor/actuator cable Cable: 3 m, 5-wire, PVC Application: Uncontaminated zones, Zones with chemicals 	YF2A15-030VB5XLEAX	2145572
Mounting systems			
	<ul style="list-style-type: none"> Description: Alignment unit for DS/DT500, stainless steel (1.4541), incl. mounting material Items supplied: Mounting hardware included 	BEF-DSDT	2031377

SICK AT A GLANCE

SICK is one of the leading manufacturers of intelligent sensors and sensor solutions for industrial applications. A unique range of products and services creates the perfect basis for controlling processes securely and efficiently, protecting individuals from accidents and preventing damage to the environment.

We have extensive experience in a wide range of industries and understand their processes and requirements. With intelligent sensors, we can deliver exactly what our customers need. In application centers in Europe, Asia and North America, system solutions are tested and optimized in accordance with customer specifications. All this makes us a reliable supplier and development partner.

Comprehensive services complete our offering: SICK LifeTime Services provide support throughout the machine life cycle and ensure safety and productivity.

For us, that is “Sensor Intelligence.”

WORLDWIDE PRESENCE:

Contacts and other locations –www.sick.com