



MZ2Q-CSSPSKQ0

MZ2Q-C

CYLINDER SENSORS

SICK
Sensor Intelligence.



Ordering information

Type	part no.
MZ2Q-CSSPSKQ0	1042240

Other models and accessories → www.sick.com/MZ2Q-C



Detailed technical data

Features

Cylinder type	C-slot
Preferred manufacturer slot	SMC Bimba
Detection zone	0 mm ... 50 mm
Cylinder types with adapter	SMC rail ECDQ2 SMC rail CDQ2
Housing length	19.5 mm
Switching output	2 x PNP
Output function	2 x N/O contact
Electrical wiring	DC 4-wire
Enclosure rating	IP67 ¹⁾
Adjustment	
Teach-in control panel	Teaching in switching points 1 and 2

¹⁾ According to EN 60529.

Mechanics/electronics

Detection zone	0 mm ... 50 mm
Supply voltage	12 V DC ... 30 V DC
Power consumption	Typ. 20 mA, without load
Voltage drop	≤ 2.2 V
Continuous current I_a	≤ 100 mA
Protection class	III
Hysteresis, typ.	1 mT
Reproducibility	≤ 0.1 mT ¹⁾
Reverse polarity protection	Yes

¹⁾ Supply voltage U_B and constant ambient temperature T_a.

Short-circuit protection	Yes
Status indicator LED	Yes
Teach-in	Yes
Power-up pulse protection	Yes
Ambient operating temperature	-20 °C ... +75 °C
Shock and vibration resistance	30 g, 11 ms / 10 ... 55 Hz, 1 mm
EMC	According to EN 60947-5-2
Connection type	Cable with connector M12, 4-pin, with knurled nut, 0.3 m
Connection type Detail	
Conductor cross section	0.08 mm ²
Cable diameter	Ø 2.6 mm
Bending radius	With fixed installation > 5 x cable diameter For flexible use > 10 x cable diameter
Cable outlet	Axial
Control elements connection cable	
Connection type	Cable, 4-wire, 0.1 m
Control elements connection cable detail	
Conductor size	0.08 mm ²
Cable diameter	Ø 2.3 mm
Bending radius	With fixed installation > 5 x cable diameter For flexible use > 10 x cable diameter
Cable outlet	Axial
Material	
Housing	Plastic
Cable	PUR
UL File No.	NRKH.E181493 & NRKH7.E181493

¹⁾ Supply voltage U_B and constant ambient temperature T_a .

Safety-related parameters

MTTF_D	799 years
DC_{avg}	0%
T_M (mission time)	20 years

Certificates

EU declaration of conformity	✓
UK declaration of conformity	✓
ACMA declaration of conformity	✓
Moroccan declaration of conformity	✓
China RoHS	✓
cULus certificate	✓

Classifications

ECLASS 5.0	27270104
ECLASS 5.1.4	27270104

ECLASS 6.0	27270104
ECLASS 6.2	27270104
ECLASS 7.0	27270104
ECLASS 8.0	27270104
ECLASS 8.1	27270104
ECLASS 9.0	27270104
ECLASS 10.0	27270104
ECLASS 11.0	27270104
ECLASS 12.0	27274301
ETIM 5.0	EC002544
ETIM 6.0	EC002544
ETIM 7.0	EC002544
ETIM 8.0	EC002544
UNSPSC 16.0901	39122230

Installation note

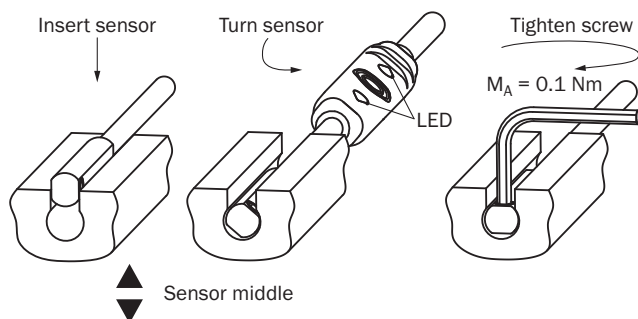

Connection type



Connection diagram Cd-032

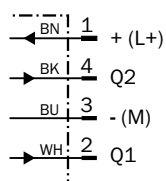

Dimensional drawing Cable with M12 male connector

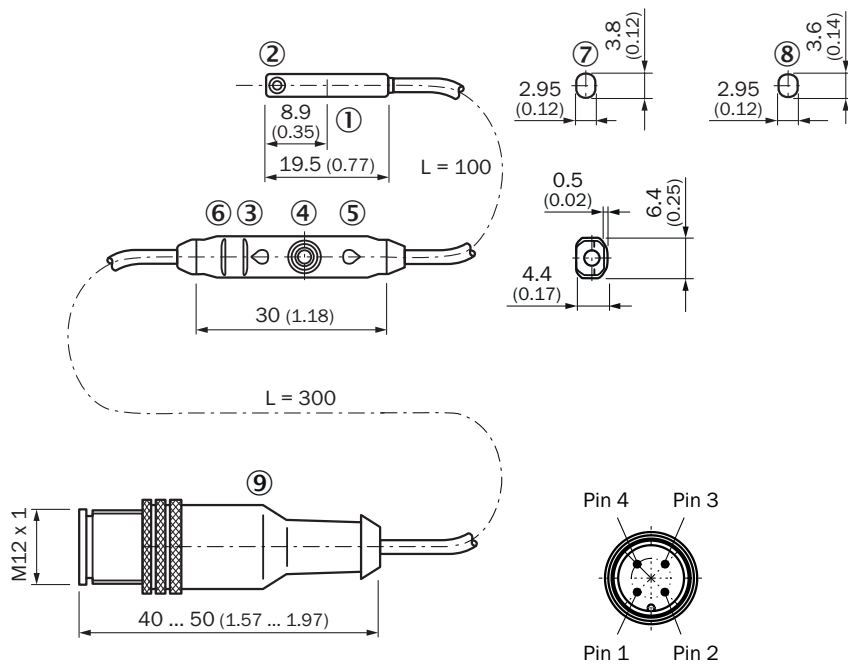











Dimensions in mm (inch)

- ① Center of sensor element
- ② Fixing screw SW 1.3
- ③ Display LED
- ④ Teach-in button
- ⑤ Display LED
- ⑥ ribbing for cable ties
- ⑦ For SMC/ Bimba cylinder (MZ2Q-CSxxxx)
- ⑧ For festo cylinder (MZ2Q-CFxxxx)
- ⑨ Connection

Recommended accessories

Other models and accessories → www.sick.com/MZ2Q-C

	Brief description	Type	part no.
Mounting systems			
	<ul style="list-style-type: none"> Description: Mounting bracket on round body cylinder with piston diameter of 1 mm ... 130 mm, ambient temperature min -30 °C max 80 °C Material: Stainless steel, Aluminum Details: Stainless steel, Aluminum Packing unit: 1 piece Suitable for: C-slot 	BEF-KHZ-RC1-130	2077686
	<ul style="list-style-type: none"> Description: Mounting bracket on round body cylinder with piston diameter of 12 mm, ambient temperature min 0 °C max 50 °C Material: Plastic, Aluminum Details: Plastic, Aluminum Packing unit: 1 piece Suitable for: C-slot 	BEF-KHZ-RC-12	2077673
	<ul style="list-style-type: none"> Description: Mounting bracket on round body cylinder with piston diameter of 1 mm ... 25 mm, ambient temperature min -30 °C max 80 °C Material: Stainless steel, Aluminum Details: Stainless steel, Aluminum Packing unit: 1 piece Suitable for: C-slot 	BEF-KHZ-RC1-25	2077685
	<ul style="list-style-type: none"> Description: Mounting bracket on round body cylinder with piston diameter of 16 mm, ambient temperature min 0 °C max 50 °C Material: Plastic, Aluminum Details: Plastic, Aluminum Packing unit: 1 piece Suitable for: C-slot 	BEF-KHZ-RC-16	2077672
	<ul style="list-style-type: none"> Description: Mounting bracket on round body cylinder with piston diameter of 20 mm, ambient temperature min 0 °C max 50 °C Material: Plastic, Aluminum Details: Plastic, Aluminum Packing unit: 1 piece Suitable for: C-slot 	BEF-KHZ-RC-20	2077671
	<ul style="list-style-type: none"> Description: Mounting bracket on round body cylinder with piston diameter of 25 mm, ambient temperature min 0 °C max 50 °C Material: Plastic, Aluminum Details: Plastic, Aluminum Packing unit: 1 piece Suitable for: C-slot 	BEF-KHZ-RC-25	2077670
	<ul style="list-style-type: none"> Description: Mounting bracket on round body cylinder with piston diameter of 32 mm, ambient temperature min 0 °C max 50 °C Material: Plastic, Aluminum Details: Plastic, Aluminum Packing unit: 1 piece Suitable for: C-slot 	BEF-KHZ-RC-32	2077669
	<ul style="list-style-type: none"> Description: Mounting bracket on round body cylinder with piston diameter of 40 mm, ambient temperature min 0 °C max 50 °C Material: Plastic, Aluminum Details: Plastic, Aluminum Packing unit: 1 piece Suitable for: C-slot 	BEF-KHZ-RC-40	2077668
	<ul style="list-style-type: none"> Description: Mounting bracket on round body cylinder with piston diameter of 50 mm, ambient temperature min 0 °C max 50 °C Material: Plastic, Aluminum Details: Plastic, Aluminum Packing unit: 1 piece Suitable for: C-slot 	BEF-KHZ-RC-50	2077667
	<ul style="list-style-type: none"> Description: Mounting bracket on round body cylinder with piston diameter of 63 mm, ambient temperature min 0 °C max 50 °C Material: Plastic, Aluminum Details: Plastic, Aluminum Packing unit: 1 piece Suitable for: C-slot 	BEF-KHZ-RC-63	2077666

	Brief description	Type	part no.
connectors and cables			
	<ul style="list-style-type: none"> Description: Unshielded Connection type head A: Female connector, M12, 4-pin, straight, A-coded Connection systems: Screw-type terminals Permitted cross-section: ≤ 0.75 mm² 	DOS-1204-G	6007302
	<ul style="list-style-type: none"> Description: Unshielded Connection type head A: Female connector, M12, 4-pin, angled, A-coded Connection systems: Screw-type terminals Permitted cross-section: ≤ 0.75 mm² 	DOS-1204-W	6007303
	<ul style="list-style-type: none"> Description: Unshielded Connection type head A: Male connector, M12, 4-pin, straight, A-coded Connection systems: Screw-type terminals Permitted cross-section: ≤ 0.75 mm² 	STE-1204-G	6009932
	<ul style="list-style-type: none"> Description: Unshielded Connection type head A: Male connector, M12, 4-pin, angled, A-coded Connection systems: Screw-type terminals Permitted cross-section: ≤ 0.75 mm² 	STE-1204-W	6022084
	<ul style="list-style-type: none"> Description: Sensor/actuator cable, unshielded Connection type head A: Female connector, M12, 4-pin, angled, A-coded Connection type head B: Flying leads Signal type: Sensor/actuator cable Cable: 0.6 m, 4-wire, PVC Application: Uncontaminated zones, Zones with chemicals 	YG2A14-C60VB3XLEAX	2145709
	<ul style="list-style-type: none"> Description: Sensor/actuator cable, unshielded Connection type head A: Female connector, M12, 4-pin, angled, A-coded Connection type head B: Flying leads Signal type: Sensor/actuator cable Cable: 1 m, 4-wire, PVC Application: Uncontaminated zones, Zones with chemicals 	YG2A14-010VB3XLEAX	2145710
	<ul style="list-style-type: none"> Description: Sensor/actuator cable, unshielded Connection type head A: Female connector, M12, 4-pin, angled, A-coded Connection type head B: Flying leads Signal type: Sensor/actuator cable Cable: 0.6 m, 4-wire, PVC Note: Only suitable for PNP sensors Application: Uncontaminated zones, Zones with chemicals 	YI2A14-C60VB3XLEAX	2145719
	<ul style="list-style-type: none"> Description: Sensor/actuator cable, unshielded Connection type head A: Female connector, M12, 4-pin, angled, A-coded Connection type head B: Flying leads Signal type: Sensor/actuator cable Cable: 1 m, 4-wire, PVC Note: Only suitable for PNP sensors Application: Uncontaminated zones, Zones with chemicals 	YI2A14-010VB3XLEAX	2145720
	<ul style="list-style-type: none"> Description: Sensor/actuator cable, unshielded Connection type head A: Female connector, M12, 4-pin, angled, A-coded Connection type head B: Flying leads Signal type: Sensor/actuator cable Cable: 3 m, 4-wire, PVC Note: Only suitable for PNP sensors Application: Uncontaminated zones, Zones with chemicals 	YI2A14-030VB3XLEAX	2145721
	<ul style="list-style-type: none"> Description: Sensor/actuator cable, unshielded Connection type head A: Female connector, M12, 4-pin, straight, A-coded Connection type head B: Flying leads Signal type: Sensor/actuator cable Cable: 0.6 m, 4-wire, PVC Application: Uncontaminated zones, Zones with chemicals 	YF2A14-C60VB3XLEAX	2145707
	<ul style="list-style-type: none"> Description: Sensor/actuator cable, unshielded Connection type head A: Female connector, M12, 4-pin, straight, A-coded Connection type head B: Flying leads Signal type: Sensor/actuator cable Cable: 1 m, 4-wire, PVC Application: Uncontaminated zones, Zones with chemicals 	YF2A14-010VB3XLEAX	2145708

SICK AT A GLANCE

SICK is one of the leading manufacturers of intelligent sensors and sensor solutions for industrial applications. A unique range of products and services creates the perfect basis for controlling processes securely and efficiently, protecting individuals from accidents and preventing damage to the environment.

We have extensive experience in a wide range of industries and understand their processes and requirements. With intelligent sensors, we can deliver exactly what our customers need. In application centers in Europe, Asia and North America, system solutions are tested and optimized in accordance with customer specifications. All this makes us a reliable supplier and development partner.

Comprehensive services complete our offering: SICK LifeTime Services provide support throughout the machine life cycle and ensure safety and productivity.

For us, that is “Sensor Intelligence.”

WORLDWIDE PRESENCE:

Contacts and other locations –www.sick.com