



CLV632-6000

CLV63x

FIXED MOUNT BARCODE SCANNERS

SICK
Sensor Intelligence.



Ordering information

| Type | part no. |
|-------------|----------|
| CLV632-6000 | 1041996 |

Other models and accessories → www.sick.com/CLV63x



Detailed technical data

Features

| | |
|-------------------------------------|---|
| Version | Short Range |
| Connection type | Cable |
| Reading field | Oscillating mirror |
| Sensor type | Line scanner |
| Optical focus | Fixed focus |
| Light source | Light spot, laser, Visible, Red, 655 nm |
| Light spot | Circular |
| Laser class | 2, complies with 21 CFR 1040.10 except for the conformance according to "Laser Notice No. 56" from May 8, 2019 (EN 60825-1:2014+A11:2021, IEC 60825-1:2014) |
| Aperture angle | ≤ 50° |
| Reading distance | 45 mm ... 245 mm ¹⁾ |
| Scanning frequency | 400 Hz ... 1,200 Hz |
| Code resolution | 0.2 mm ... 0.5 mm |
| Oscillating mirror functions | Fixed (adjustable position), oscillating (variable or fixed amplitude), one shot |
| Oscillation frequency | 0.5 Hz ... 6.25 Hz |
| Angle of deflection | -20° ... 20° |

¹⁾ For details see reading field diagram.

Mechanics/electronics

| | |
|------------------------|--|
| Connection type | 1 x 15-pin D-Sub HD male connector (0.9 m) |
|------------------------|--|

¹⁾ At 25 °C.

| | |
|-------------------------------|--------------------------------------|
| Supply voltage | 18 V DC ... 30 V DC |
| Power consumption | 6 W |
| Housing material | Aluminum die cast |
| Housing color | Light blue (RAL 5012) |
| Window material | Glass |
| Enclosure rating | IP65 (EN 60529) |
| Protection class | III (EN 61140) |
| Weight | 420 g, with connecting cable |
| Dimensions (L x W x H) | 95 mm x 107 mm x 41 mm |
| MTBF | 100,000 h |
| MTTF | 40,000 h (Laser diode) ¹⁾ |

¹⁾ At 25 °C.

Performance

| | |
|---|---|
| Readable code structures | 1D codes |
| Bar code types | All current code types, Code 39, Code 128, Code 93, Codabar, GS1-128 / EAN 128, UPC / GTIN / EAN, Interleaved 2 of 5, Pharmacode, GS1 DataBar, Telepen, MSI/Plessey |
| Code printing process | Label (printed codes) |
| Print ratio | 2:1 ... 3:1 |
| No. of codes per scan | 1 ... 20 (Standard decoder) 1 ... 6 (SMART decoder) |
| No. of codes per reading interval | 1 ... 50 (auto-discriminating) |
| No. of characters per reading interval | 5,000 500 (for multiplexer function in CAN operation) |
| No. of multiple readings | 1 ... 99 |

Interfaces

| | |
|------------------------------|---|
| PROFINET | ✓ |
| Type of fieldbus integration | Optional over external fieldbus module CDF600-2 |
| Function | PROFINET Single Port, PROFINET Dual Port |
| EtherCAT® | ✓ |
| Type of fieldbus integration | Optional over external fieldbus module CDF600 |
| Serial | ✓, RS-232, RS-422, RS-485 |
| Function | Data interface (read result output), Service interface |
| Data transmission rate | 2,400 Baud ... 115.2 kBaud, AUX: 57.6 kBaud (RS-232) |
| CAN | ✓ |
| Function | SICK CAN sensor network CSN (CAN controller/CAN device, multiplexer/server) |
| Data transmission rate | 20 kbit/s ... 1 Mbit/s |
| CANopen | ✓ |
| Data transmission rate | 20 kbit/s ... 1 Mbit/s |
| PROFIBUS DP | ✓ |
| Type of fieldbus integration | Optional over external fieldbus module CDF600-2 |
| Digital inputs | 4 ("Sensor 1", "Sensor 2", 2 inputs via optional parameter storage CMC600 in CDB620/CDM420) |

| | |
|-------------------------------|--|
| Digital outputs | 4 ("Result 1", "Result 2", 2 outputs via optional parameter storage CMC600 in CDB620/CDM420) |
| Reading pulse | Digital inputs, non-powered, serial interface, auto pulse, CAN |
| Optical indicators | 6 LEDs (Ready, Result, laser, Data, CAN, LNK TX, Bar graph for displaying the reading rate percentage (10 LEDs)) |
| Acoustic indicators | Beeper/buzzer (can be switched off, can be allocated as a result indication function) |
| Control elements | 2 buttons (choose and start/stop functions) |
| Configuration software | SOPAS ET |
| Memory card | MicroSD memory card (flash card), optional |

Ambient data

| | |
|--|--|
| Electromagnetic compatibility (EMC) | EN 61000-6-3 (2001-10) / EN 61000-6-2:2005 |
| Vibration resistance | EN 60068-2-6 (1995) |
| Shock resistance | EN 60068-2-27 (1993) |
| Ambient operating temperature | 0 °C ... +40 °C |
| Storage temperature | -20 °C ... +70 °C |
| Relative humidity | 90 %, Non-condensing |
| Ambient light immunity | 2,000 lx, on barcode |
| Bar code print contrast (PCS) | ≥ 60 % |

General notes

| | |
|--------------------|--|
| Note on use | For Ethernet connection please use an Ethernet version of CLV6xx |
|--------------------|--|

Certificates

| | |
|--|---|
| EU declaration of conformity | ✓ |
| UK declaration of conformity | ✓ |
| ACMA declaration of conformity | ✓ |
| China RoHS | ✓ |
| cULus certificate | ✓ |
| KC Mark certificate | ✓ |
| Ethercat certificate | ✓ |
| Profinet certificate | ✓ |
| Laser safety (IEC 60825-1) declaration of manufacturer | ✓ |
| Information according to Art. 3 of Data Act (Regulation EU 2023/2854) | ✓ |
| 4Dpro | ✓ |

Classifications

| | |
|---------------------|----------|
| ECLASS 5.0 | 27280102 |
| ECLASS 5.1.4 | 27280102 |
| ECLASS 6.0 | 27280102 |
| ECLASS 6.2 | 27280102 |
| ECLASS 7.0 | 27280102 |
| ECLASS 8.0 | 27280102 |
| ECLASS 8.1 | 27280102 |

| | |
|-----------------------|----------|
| ECLASS 9.0 | 27280102 |
| ECLASS 10.0 | 27280102 |
| ECLASS 11.0 | 27280102 |
| ECLASS 12.0 | 27280102 |
| ETIM 5.0 | EC002550 |
| ETIM 6.0 | EC002550 |
| ETIM 7.0 | EC002550 |
| ETIM 8.0 | EC002550 |
| UNSPSC 16.0901 | 43211701 |

Dimensional drawing CLV63x/64x/65x Standard, oscillating mirror

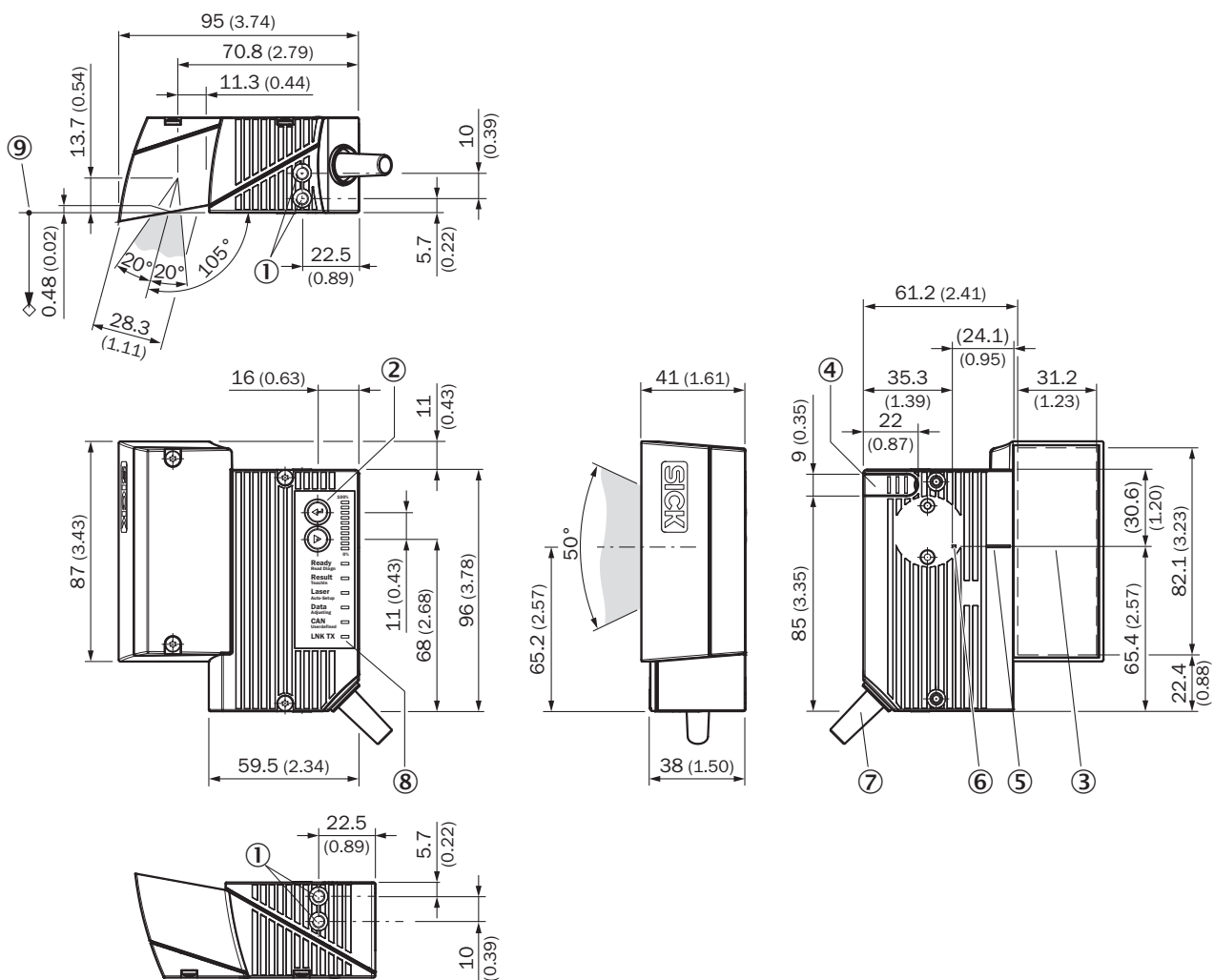

Dimensions in mm (inch)

- ① blind hole thread M5, 5 mm deep (2 x), for mounting
- ② Function button (2 x)
- ③ Reading field
- ④ cover for the microSD memory card
- ⑤ central position of the deflected laser beam in the V-shaped aperture angle
- ⑥ internal impact point: rotation point of the variable direction laser beam

- ⑦ Cable with 15-pin D-sub HD male connector
- ⑧ LED status indicator (6x) and bar graph
- ⑨ reference point for reading distance (from housing edge to object)

Reading field diagram

Reading field height in mm (inch)

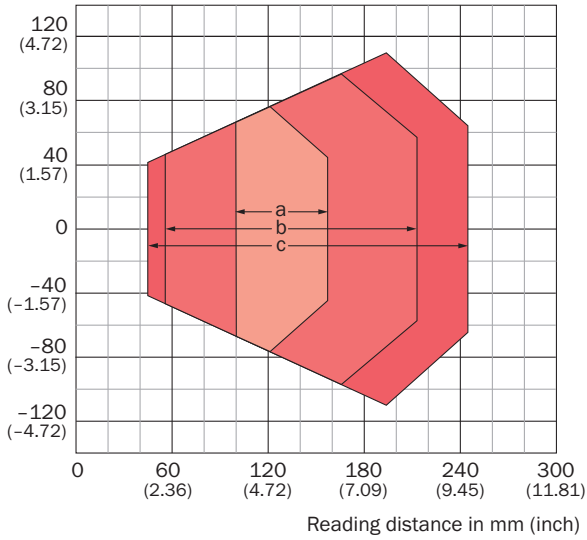

Resolution

- a: 0.20 mm (7.9 mil)
- b: 0.35 mm (13.8 mil)
- c: 0.50 mm (19.7 mil)

Deflection width

Deflection range in mm (inch)

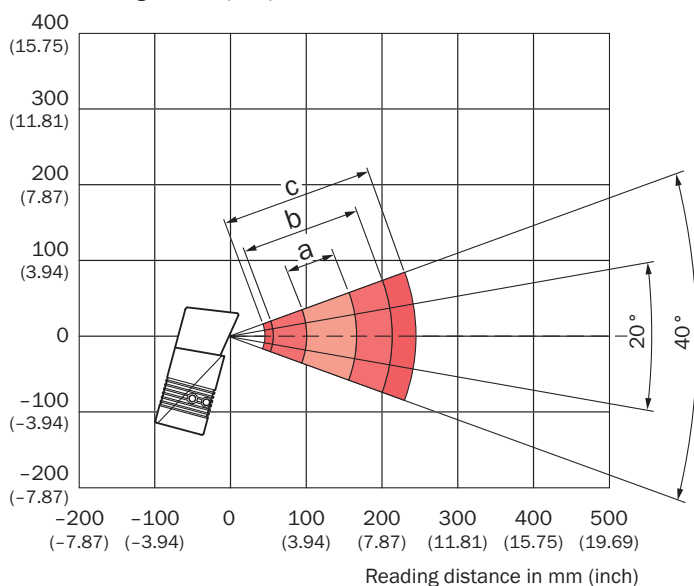





Resolution

- a: 0.20 mm (7.9 mil)
- b: 0.35 mm (13.8 mil)
- c: 0.50 mm (19.7 mil)

Recommended accessories

Other models and accessories → www.sick.com/CLV63x

| | Brief description | Type | part no. |
|---|---|---------------------|----------|
| integration modules and adapters | | | |
|  | <ul style="list-style-type: none"> Description: External parameter memory for integration in CDB620/CDB650/CDM42x | CMC600-101 | 1042259 |
| Storage media | | | |
|  | <ul style="list-style-type: none"> Description: microSD memory card with 1 GB for industrial use | microSD memory card | 4051366 |
| Mounting systems | | | |
|  | <ul style="list-style-type: none"> Description: Hanger-shaped mounting bracket Items supplied: Mounting hardware included | Mounting bracket | 2042800 |
| Junction boxes | | | |
|  | | CDB620-001 | 1042256 |

SICK AT A GLANCE

SICK is one of the leading manufacturers of intelligent sensors and sensor solutions for industrial applications. A unique range of products and services creates the perfect basis for controlling processes securely and efficiently, protecting individuals from accidents and preventing damage to the environment.

We have extensive experience in a wide range of industries and understand their processes and requirements. With intelligent sensors, we can deliver exactly what our customers need. In application centers in Europe, Asia and North America, system solutions are tested and optimized in accordance with customer specifications. All this makes us a reliable supplier and development partner.

Comprehensive services complete our offering: SICK LifeTime Services provide support throughout the machine life cycle and ensure safety and productivity.

For us, that is “Sensor Intelligence.”

WORLDWIDE PRESENCE:

Contacts and other locations –www.sick.com