



DS500-P411

Dx500

TIME-OF-FLIGHT SENSORS

SICK
Sensor Intelligence.



Ordering information

| Type | part no. |
|------------|----------|
| DS500-P411 | 1040478 |

Other models and accessories → www.sick.com/Dx500



Detailed technical data

Features

| | |
|----------------------------------|---|
| Measuring range | 0.2 m ... 7 m, 90% remission factor ^{1) 2)} 0.8 m ... 7 m, 6% remission factor ^{1) 2)} |
| Target | Natural objects |
| Resolution | ≤ 1 mm |
| Repeatability | 1 mm |
| Measurement accuracy | ± 3 mm |
| Response time | 150 ms |
| Output time | 150 ms |
| Emitted beam | |
| Light source | Laser, red ³⁾ |
| Type of light | Visible red light |
| Typ. light spot size (distance) | 10 mm (at 7 m) 45 mm (at 30 m) 100 mm (at 70 m) |
| Key laser figures | |
| Normative reference | IEC 60825-1:2014, EN 60825-1:2014 |
| Laser class | 2 ⁴⁾ |
| Safety-related parameters | |
| MTTF _D | 101 years |
| DC _{avg} | 0% |

¹⁾ In ambient light, max. 1 klx of constant light.

²⁾ Unique up to 7 m.

³⁾ Average service life of 50,000 h at T_A = +25 °C.

⁴⁾ Do not intentionally look into the laser beam. Never point the laser beam at people's eyes.

Interfaces

| | | |
|-----------------------------------|------------------------------|----------------------|
| Digital output | Number | 2 ¹⁾ |
| | Type | PNP |
| | Maximum output current I_A | ≤ 100 mA |
| Multifunctional input (MF) | | PNP ^{2) 3)} |
| Hysteresis | | ± 6 % |

¹⁾ HIGH = UV - (<2,5 V) / LOW = < 2,5 V; active HIGH / aktive LOW konfigurierbar.

²⁾ Refer to function MF input.

³⁾ HIGH = UV - (<2,5 V) / LOW = < 2,5 V; active HIGH.

Electronics

| | |
|--|---|
| Supply voltage U_B | DC 10 V ... 30 V, reverse polarity protected $U_V \geq$ DC 24 V for devices with heating |
| Power consumption | Typ. 22 W |
| Ripple | 5 V _{pp} ¹⁾ |
| Initialization time | 500 ms |
| Enclosure rating | IP65 |
| Protection class | II ²⁾ |
| Connection type | Male connector |

¹⁾ May not fall short of or exceed V_S tolerances.

²⁾ Reference voltage DC 32 V.

Mechanics

| | |
|-------------------------------|---------------------------|
| Dimensions (W x H x D) | 69 mm x 50 mm x 153 mm |
| Housing material | Metal (Aluminum die cast) |
| Window material | Glass |
| Weight | 1,000 g |

Ambient data

| | |
|--|---|
| Ambient temperature, operation | -40 °C ... +45 °C, operation with heating -40 °C ... +75 °C, operation with cooling case |
| Ambient temperature, storage | -25 °C ... +75 °C |
| Temperature drift | Typ. 0.05 mm/K |
| Typ. Ambient light immunity | ≤ 3,000 lx |
| Mechanical load | Shock: (EN 600 68-2-27) Sine: (EN 600 68-2-6) Noise: (EN 600 68-2-64) |
| Electromagnetic compatibility (EMC) | EN 61000-6-2 / EN 61000-6-3 |

Certificates

| | |
|---------------------------------------|---|
| EU declaration of conformity | ✓ |
| UK declaration of conformity | ✓ |
| ACMA declaration of conformity | ✓ |

| | |
|------------------------------------|---|
| Moroccan declaration of conformity | ✓ |
| China RoHS | ✓ |

Classifications

| | |
|-----------------------|----------|
| ECLASS 5.0 | 27270801 |
| ECLASS 5.1.4 | 27270801 |
| ECLASS 6.0 | 27270801 |
| ECLASS 6.2 | 27270801 |
| ECLASS 7.0 | 27270801 |
| ECLASS 8.0 | 27270801 |
| ECLASS 8.1 | 27270801 |
| ECLASS 9.0 | 27270801 |
| ECLASS 10.0 | 27270801 |
| ECLASS 11.0 | 27270801 |
| ECLASS 12.0 | 27270916 |
| ETIM 5.0 | EC001825 |
| ETIM 6.0 | EC001825 |
| ETIM 7.0 | EC001825 |
| ETIM 8.0 | EC001825 |
| UNSPSC 16.0901 | 41111613 |

Dimensional drawing

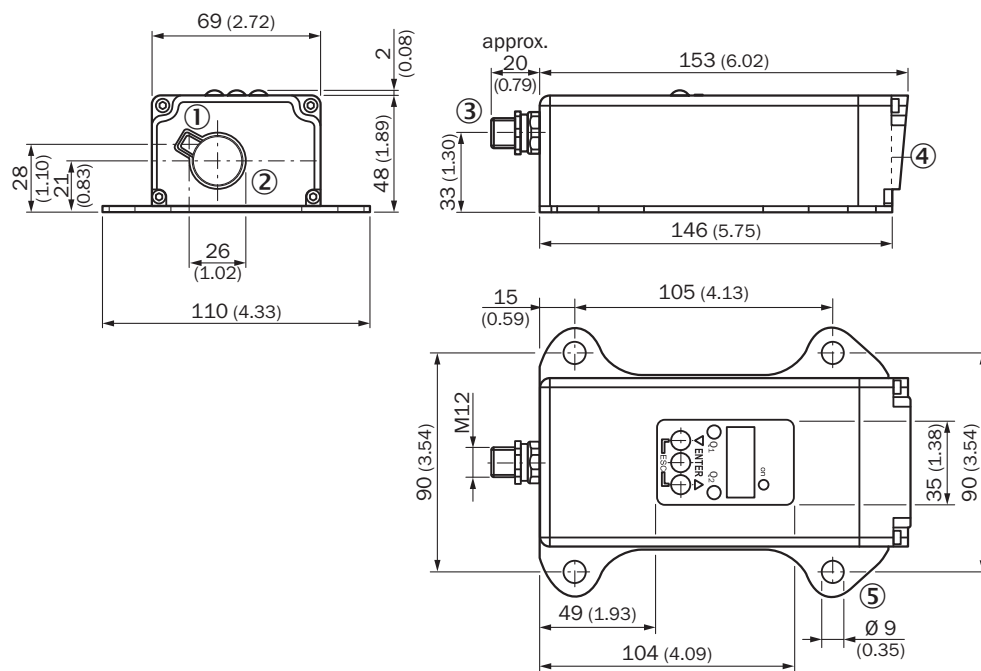

Dimensions in mm (inch)

- ① Optical axis, sender
- ② Optical axis, receiver
- ③ Plug, M12, 5-pin

- ④ Zero level
- ⑤ fixing hole

Connection type Plug, M12, 5-pin



Connection diagram

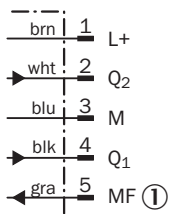

① Multifunctional input (MF)

Adjustment possible

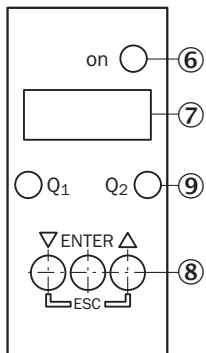

- ⑥ Operating indicator
- ⑦ Indicator panel, 7-segment display
- ⑧ Control panel
- ⑨ digital output display

Additional information

Extern Teach ET via MF ①

| Teach-in | MF active | Model |
|----------------|-----------|--|
| Q ₁ | 100 ms | Current measurement value is used as switching threshold |
| \bar{Q}_1 | 200 ms | |
| Q ₂ | 300 ms | |
| \bar{Q}_2 | 400 ms | |
| Laser off | > 450 ms | |

① Multi functional input.

Error performance or no object in measurement range

Measurement not possible

| Measurement value output display | Switching outputs |
|----------------------------------|---|
| 0.000 | Switching stage $\hat{=}$ measurement value 0 m |

No object in measurement range or laser off

| Measurement value output display | Switching outputs |
|----------------------------------|---|
| 99.99 | Switching stage $\hat{=}$ measurement value 99.99 m |

function MF input





Function MF input

| | | |
|-----------|----------------|----------------------|
| Teach in | Q ₁ | 60 ms < MF < 150 ms |
| Teach in | \bar{Q}_1 | 150 ms < MF < 250 ms |
| Teach in | Q ₂ | 250 ms < MF < 350 ms |
| Teach in | \bar{Q}_2 | 350 ms < MF < 450 ms |
| Laser off | - | 450 ms < MF < ∞ |

Recommended accessories

Other models and accessories → www.sick.com/Dx500

| | Brief description | Type | part no. |
|---|---|----------|----------|
| Mounting systems | | | |
|  | <ul style="list-style-type: none"> Description: Alignment unit for DS/DT500, stainless steel (1.4541), incl. mounting material Items supplied: Mounting hardware included | BEF-DSDT | 2031377 |

| | Brief description | Type | part no. |
|---|---|--------------------|----------|
| connectors and cables | | | |
|  | <ul style="list-style-type: none"> • Description: Sensor/actuator cable, unshielded • Connection type head A: Female connector, M12, 5-pin, straight, A-coded • Connection type head B: Flying leads • Signal type: Sensor/actuator cable • Cable: 2 m, 5-wire, PVC • Application: Uncontaminated zones, Zones with chemicals | YF2A15-020VB5XLEAX | 2096239 |
|  | <ul style="list-style-type: none"> • Description: Sensor/actuator cable, unshielded • Connection type head A: Female connector, M12, 5-pin, straight, A-coded • Connection type head B: Flying leads • Signal type: Sensor/actuator cable • Cable: 5 m, 5-wire, PVC • Application: Uncontaminated zones, Zones with chemicals | YF2A15-050VB5XLEAX | 2096240 |
|  | <ul style="list-style-type: none"> • Description: Sensor/actuator cable, unshielded • Connection type head A: Female connector, M12, 5-pin, straight, A-coded • Connection type head B: Flying leads • Signal type: Sensor/actuator cable • Cable: 10 m, 5-wire, PVC • Application: Uncontaminated zones, Zones with chemicals | YF2A15-100VB5XLEAX | 2096241 |
|  | <ul style="list-style-type: none"> • Description: Sensor/actuator cable, unshielded • Connection type head A: Female connector, M12, 5-pin, straight, A-coded • Connection type head B: Flying leads • Signal type: Sensor/actuator cable • Cable: 0.6 m, 5-wire, PVC • Application: Uncontaminated zones, Zones with chemicals | YF2A15-C60VB5XLEAX | 2145570 |
|  | <ul style="list-style-type: none"> • Description: Sensor/actuator cable, unshielded • Connection type head A: Female connector, M12, 5-pin, straight, A-coded • Connection type head B: Flying leads • Signal type: Sensor/actuator cable • Cable: 3 m, 5-wire, PVC • Application: Uncontaminated zones, Zones with chemicals | YF2A15-030VB5XLEAX | 2145572 |

SICK AT A GLANCE

SICK is one of the leading manufacturers of intelligent sensors and sensor solutions for industrial applications. A unique range of products and services creates the perfect basis for controlling processes securely and efficiently, protecting individuals from accidents and preventing damage to the environment.

We have extensive experience in a wide range of industries and understand their processes and requirements. With intelligent sensors, we can deliver exactly what our customers need. In application centers in Europe, Asia and North America, system solutions are tested and optimized in accordance with customer specifications. All this makes us a reliable supplier and development partner.

Comprehensive services complete our offering: SICK LifeTime Services provide support throughout the machine life cycle and ensure safety and productivity.

For us, that is “Sensor Intelligence.”

WORLDWIDE PRESENCE:

Contacts and other locations –www.sick.com