



# DT500-A411

Dx500

TIME-OF-FLIGHT SENSORS

**SICK**  
Sensor Intelligence.



### Ordering information

Type	part no.
DT500-A411	1040465

Other models and accessories → [www.sick.com/Dx500](http://www.sick.com/Dx500)



### Detailed technical data

#### Features

<b>Measuring range</b>	0.2 m ... 7 m, 90% remission factor <sup>1) 2)</sup> 0.8 m ... 7 m, 6% remission factor <sup>1) 2)</sup>
<b>Target</b>	Natural objects
<b>Resolution</b>	12 bit
<b>Repeatability</b>	1 mm <sup>3) 4)</sup>
<b>Measurement accuracy</b>	± 3 mm
<b>Response time</b>	150 ms
<b>Output time</b>	150 ms
<b>Emitted beam</b>	
Light source	Laser, red <sup>5)</sup>
Type of light	Visible red light
Typ. light spot size (distance)	10 mm (at 7 m) 45 mm (at 30 m) 100 mm (at 70 m)
<b>Key laser figures</b>	
Normative reference	IEC 60825-1:2014, EN 60825-1:2014
Laser class	2 <sup>6)</sup>
<b>Heating</b>	✓
<b>Safety-related parameters</b>	
MTTF <sub>D</sub>	101 years
DC <sub>avg</sub>	0%

<sup>1)</sup> In ambient light, max. 1 klx of constant light.

<sup>2)</sup> Unique up to 7 m.

<sup>3)</sup> 6% ... 90% remission factor.

<sup>4)</sup> Statistical error 1  $\sigma$ .

<sup>5)</sup> Average service life of 50,000 h at T<sub>A</sub> = +25 °C.

<sup>6)</sup> Do not intentionally look into the laser beam. Never point the laser beam at people's eyes.

## Interfaces

<b>Analog output</b>	Number	1
	Type	Current output
	Current	0 mA ... 20 mA <sup>1)</sup>
<b>Multifunctional input (MF)</b>		PNP <sup>2) 3)</sup>
<b>Laser-off input</b>		> 12 V

<sup>1)</sup> Can be configured to the device: 0 mA ... 20 mA / 4 mA ... 20 mA (max. load resistance =  $U_V - 2 \text{ V} / 0.0205 \text{ A}$ ).

<sup>2)</sup> Refer to function MF input.

<sup>3)</sup> HIGH = UV - (< 2 V) / LOW = < 2 V; active HIGH.

## Electronics

<b>Supply voltage <math>U_B</math></b>	DC 10 V ... 30 V, reverse polarity protected $U_V \geq \text{DC } 24 \text{ V}$ for devices with heating
<b>Power consumption</b>	Typ. 22 W
<b>Ripple</b>	5 V <sub>pp</sub> <sup>1)</sup>
<b>Initialization time</b>	500 ms
<b>Enclosure rating</b>	IP65
<b>Protection class</b>	II <sup>2)</sup>
<b>Connection type</b>	Male connector

<sup>1)</sup> May not fall short of or exceed  $V_S$  tolerances.

<sup>2)</sup> Reference voltage DC 32 V.

## Mechanics

<b>Dimensions (W x H x D)</b>	69 mm x 50 mm x 153 mm
<b>Housing material</b>	Metal (Aluminum die cast)
<b>Window material</b>	Glass
<b>Weight</b>	1,000 g

## Ambient data

<b>Ambient temperature, operation</b>	-40 °C ... +45 °C, operation with heating -40 °C ... +75 °C, operation with cooling case
<b>Ambient temperature, storage</b>	-25 °C ... +75 °C
<b>Temperature drift</b>	Typ. 0.05 mm/K
<b>Typ. Ambient light immunity</b>	$\leq 3,000 \text{ lx}$
<b>Mechanical load</b>	Shock: (EN 600 68-2-27 / -2-29) Sine: (EN 600 68-2-6) Noise: (EN 600 68-2-64)
<b>Electromagnetic compatibility (EMC)</b>	EN 61000-6-2 / EN 61000-6-3

## Certificates

<b>EU declaration of conformity</b>	✓
<b>UK declaration of conformity</b>	✓
<b>ACMA declaration of conformity</b>	✓

Moroccan declaration of conformity	✓
China RoHS	✓

Classifications

<b>ECLASS 5.0</b>	27270801
<b>ECLASS 5.1.4</b>	27270801
<b>ECLASS 6.0</b>	27270801
<b>ECLASS 6.2</b>	27270801
<b>ECLASS 7.0</b>	27270801
<b>ECLASS 8.0</b>	27270801
<b>ECLASS 8.1</b>	27270801
<b>ECLASS 9.0</b>	27270801
<b>ECLASS 10.0</b>	27270801
<b>ECLASS 11.0</b>	27270801
<b>ECLASS 12.0</b>	27270916
<b>ETIM 5.0</b>	EC001825
<b>ETIM 6.0</b>	EC001825
<b>ETIM 7.0</b>	EC001825
<b>ETIM 8.0</b>	EC001825
<b>UNSPSC 16.0901</b>	41111613

Dimensional drawing

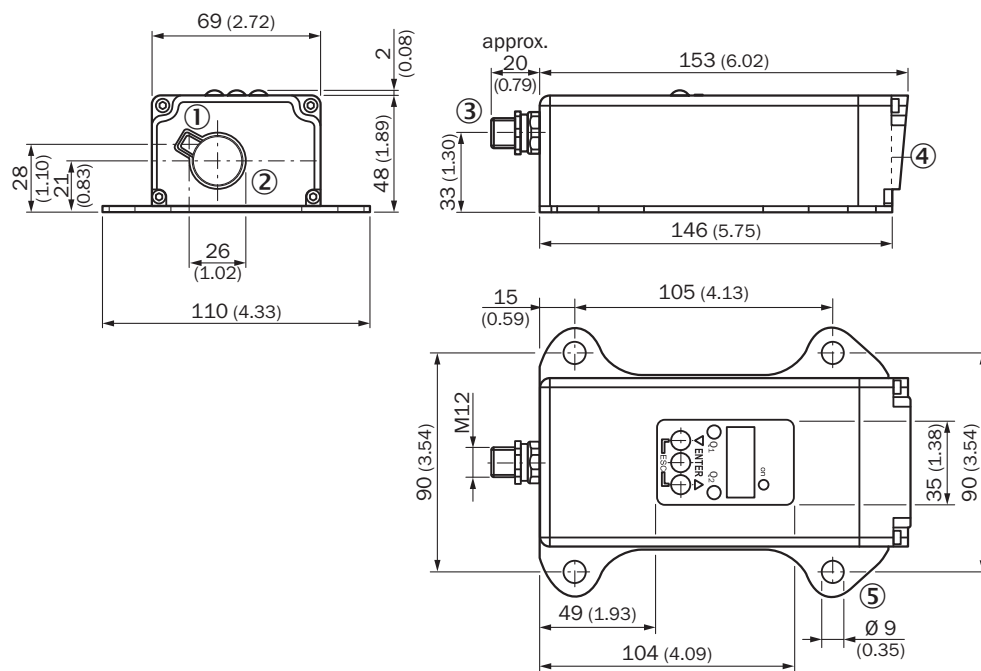

Dimensions in mm (inch)

- ① Optical axis, sender
- ② Optical axis, receiver
- ③ Plug, M12, 5-pin

- ④ Zero level
- ⑤ fixing hole

### Connection type Plug, M12, 5-pin



### Connection diagram

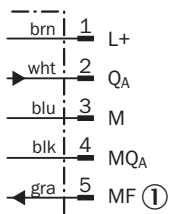

- ① Multifunctional input (MF)

### Adjustment possible

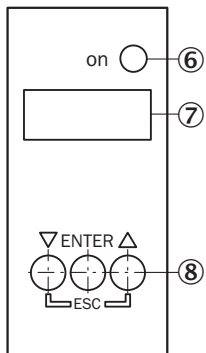

- ⑥ Operating indicator
- ⑦ Indicator panel, 7-segment display
- ⑧ Control panel

## Additional information

### Extern Teach ET via MF ①

Teach-in	MF active	Model
0 mA	100 ms	Current measurement value is used
4 mA	200 ms	
20 mA	300 ms	
Laser off	> 450 ms	

① Multi functional input.

### Error performance or no object in measurement range

#### Measurement not possible

Measurement value output display	Analog interface	CAN Bus	Serial interface
0.000	0/3.5 mA	00000	00000 CRLF

#### No object in measurement range or laser off

Measurement value output display	Analog interface	CAN Bus	Serial interface
99.99	20.5 mA	99999	99999 CRLF







## function MF input

### Function MF input

Teach in	0 mA	60 ms < MF < 150 ms
Teach in	4 mA	150 ms < MF < 250 ms
Teach in	20 mA	250 ms < MF < 350 ms
Laser off	-	450 ms < MF < ∞

## Recommended accessories

Other models and accessories → [www.sick.com/Dx500](http://www.sick.com/Dx500)

	Brief description	Type	part no.
connectors and cables			
	<ul style="list-style-type: none"> <li><b>Description:</b> Sensor/actuator cable, unshielded</li> <li><b>Connection type head A:</b> Female connector, M12, 5-pin, straight, A-coded</li> <li><b>Connection type head B:</b> Flying leads</li> <li><b>Signal type:</b> Sensor/actuator cable</li> <li><b>Cable:</b> 2 m, 5-wire, PVC</li> <li><b>Application:</b> Uncontaminated zones, Zones with chemicals</li> </ul>	YF2A15-020VB5XLEAX	2096239
	<ul style="list-style-type: none"> <li><b>Description:</b> Sensor/actuator cable, unshielded</li> <li><b>Connection type head A:</b> Female connector, M12, 5-pin, straight, A-coded</li> <li><b>Connection type head B:</b> Flying leads</li> <li><b>Signal type:</b> Sensor/actuator cable</li> <li><b>Cable:</b> 5 m, 5-wire, PVC</li> <li><b>Application:</b> Uncontaminated zones, Zones with chemicals</li> </ul>	YF2A15-050VB5XLEAX	2096240
	<ul style="list-style-type: none"> <li><b>Description:</b> Sensor/actuator cable, unshielded</li> <li><b>Connection type head A:</b> Female connector, M12, 5-pin, straight, A-coded</li> <li><b>Connection type head B:</b> Flying leads</li> <li><b>Signal type:</b> Sensor/actuator cable</li> <li><b>Cable:</b> 10 m, 5-wire, PVC</li> <li><b>Application:</b> Uncontaminated zones, Zones with chemicals</li> </ul>	YF2A15-100VB5XLEAX	2096241
	<ul style="list-style-type: none"> <li><b>Description:</b> Sensor/actuator cable, unshielded</li> <li><b>Connection type head A:</b> Female connector, M12, 5-pin, straight, A-coded</li> <li><b>Connection type head B:</b> Flying leads</li> <li><b>Signal type:</b> Sensor/actuator cable</li> <li><b>Cable:</b> 0.6 m, 5-wire, PVC</li> <li><b>Application:</b> Uncontaminated zones, Zones with chemicals</li> </ul>	YF2A15-C60VB5XLEAX	2145570
	<ul style="list-style-type: none"> <li><b>Description:</b> Sensor/actuator cable, unshielded</li> <li><b>Connection type head A:</b> Female connector, M12, 5-pin, straight, A-coded</li> <li><b>Connection type head B:</b> Flying leads</li> <li><b>Signal type:</b> Sensor/actuator cable</li> <li><b>Cable:</b> 3 m, 5-wire, PVC</li> <li><b>Application:</b> Uncontaminated zones, Zones with chemicals</li> </ul>	YF2A15-030VB5XLEAX	2145572
Mounting systems			
	<ul style="list-style-type: none"> <li><b>Description:</b> Alignment unit for DS/DT500, stainless steel (1.4541), incl. mounting material</li> <li><b>Items supplied:</b> Mounting hardware included</li> </ul>	BEF-DSDT	2031377

## SICK AT A GLANCE

SICK is one of the leading manufacturers of intelligent sensors and sensor solutions for industrial applications. A unique range of products and services creates the perfect basis for controlling processes securely and efficiently, protecting individuals from accidents and preventing damage to the environment.

We have extensive experience in a wide range of industries and understand their processes and requirements. With intelligent sensors, we can deliver exactly what our customers need. In application centers in Europe, Asia and North America, system solutions are tested and optimized in accordance with customer specifications. All this makes us a reliable supplier and development partner.

Comprehensive services complete our offering: SICK LifeTime Services provide support throughout the machine life cycle and ensure safety and productivity.

For us, that is “Sensor Intelligence.”

## WORLDWIDE PRESENCE:

Contacts and other locations –[www.sick.com](http://www.sick.com)