



# ARS60-GDA00720

ARS60

**ABSOLUTE ENCODERS**

**SICK**  
Sensor Intelligence.



## Ordering information

Type	part no.
ARS60-GDA00720	1035312

Other models and accessories → [www.sick.com/ARS60](http://www.sick.com/ARS60)

Illustration may differ



## Detailed technical data

## Safety-related parameters

<b>MTTF<sub>D</sub> (mean time to dangerous failure)</b>	300 years (EN ISO 13849-1) <sup>1)</sup>
--	--

<sup>1)</sup> This product is a standard product and does not constitute a safety component as defined in the Machinery Directive. Calculation based on nominal load of components, average ambient temperature 40 °C, frequency of use 8760 h/a. All electronic failures are considered hazardous. For more information, see document no. 8015532.

## Performance

<b>Number of steps per revolution (max. resolution)</b>	720
<b>Measuring step</b>	360° / number of steps
<b>Measuring step deviation</b>	0.016° non-binary number of steps
<b>Error limits G</b>	0.046° (non-binary number of steps) <sup>1)</sup>
<b>Repeatability standard deviation <math>\sigma_r</math></b>	0.005° <sup>2)</sup>

<sup>1)</sup> In accordance with DIN ISO 1319-1, position of the upper and lower error limit depends on the installation situation, specified value refers to a symmetrical position, i.e. deviation in upper and lower direction is the same.

<sup>2)</sup> In accordance with DIN ISO 55350-13; 68.3% of the measured values are inside the specified area.

## Interfaces

<b>Communication interface</b>	Parallel data world
<b>Initialization time</b>	80 ms <sup>1)</sup>
<b>Code type</b>	Gray, trimmed
<b>Code sequence parameter adjustable</b>	CW (clockwise) increasing when viewing the clockwise rotating shaft
<b>Measured value backlash</b>	0.005°
<b>Response threshold</b>	0.003°

<sup>1)</sup> Valid positional data can be read once this time has elapsed.

## Electronics

<b>Connection type</b>	Male connector, M23, 21-pin, radial
<b>Supply voltage</b>	10 ... 32 V

<sup>1)</sup> Only with shaft stationary (note initialisation time).

<b>Operating current</b>	Typ. 90 mA
<b>Switching level of control inputs</b>	Logic H = 0.7 x U <sub>S</sub> , Logic L = 0 V ... 0.3 x U <sub>S</sub>
<b>Actuation of set button</b>	≥ 100 ms <sup>1)</sup>

<sup>1)</sup> Only with shaft stationary (note initialisation time).

## Mechanics

<b>Mechanical design</b>	Through hollow shaft
<b>Shaft diameter</b>	12 mm <sup>1)</sup>
<b>Characteristics of the shaft</b>	Front clamp
<b>Weight</b>	Approx. 0.3 kg <sup>2)</sup>
<b>Housing material</b>	Aluminum die cast
<b>Start up torque</b>	Typ. 2.2 Ncm
<b>Operating torque</b>	Typ. 1.6 Ncm
<b>Permissible movement static</b>	± 0.3 mm (radial) ± 0.5 mm (axial)
<b>Permissible movement dynamic</b>	± 0.1 mm (radial) ± 0.2 mm (axial)
<b>Operating speed</b>	≤ 3,000 min <sup>-1</sup>
<b>Moment of inertia of the rotor</b>	See figure
<b>Bearing lifetime</b>	3.6 x 10 <sup>9</sup> revolutions
<b>Angular acceleration</b>	≤ 500,000 rad/s <sup>2</sup>

<sup>1)</sup> 12 mm requires the corresponding collet, this and other collets for 6, 8, 10 mm as well as 1/4", 3/8" and 1/2" need to be ordered separately as accessories.

<sup>2)</sup> Based on devices with male connector.

## Ambient data

<b>EMC</b>	According to EN 61000-6-2 and EN 61000-6-3 <sup>1)</sup>
<b>Enclosure rating</b>	IP64, male connector (IEC 60529) <sup>2)</sup>
<b>Permissible relative humidity</b>	90 % (Condensation not permitted)
<b>Operating temperature range</b>	-20 °C ... +85 °C
<b>Storage temperature range</b>	-40 °C ... +100 °C, without package
<b>Resistance to shocks</b>	50 g, 11 ms (EN 60068-2-27)
<b>Resistance to vibration</b>	20 g, 10 Hz ... 2,000 Hz (EN 60068-2-6)

<sup>1)</sup> EMC according to the standards quoted is achieved if shielded cables are used.

<sup>2)</sup> With mating connector fitted.

## Certificates

<b>EU declaration of conformity</b>	✓
<b>UK declaration of conformity</b>	✓
<b>ACMA declaration of conformity</b>	✓
<b>Moroccan declaration of conformity</b>	✓
<b>China RoHS</b>	✓
<b>cULus certificate</b>	✓
<b>Information according to Art. 3 of Data Act (Regulation EU 2023/2854)</b>	✓

### Classifications

<b>ECLASS 5.0</b>	27270502
<b>ECLASS 5.1.4</b>	27270502
<b>ECLASS 6.0</b>	27270590
<b>ECLASS 6.2</b>	27270590
<b>ECLASS 7.0</b>	27270502
<b>ECLASS 8.0</b>	27270502
<b>ECLASS 8.1</b>	27270502
<b>ECLASS 9.0</b>	27270502
<b>ECLASS 10.0</b>	27270502
<b>ECLASS 11.0</b>	27270502
<b>ECLASS 12.0</b>	27270502
<b>ETIM 5.0</b>	EC001486
<b>ETIM 6.0</b>	EC001486
<b>ETIM 7.0</b>	EC001486
<b>ETIM 8.0</b>	EC001486
<b>UNSPSC 16.0901</b>	41112113

### Dimensional drawing

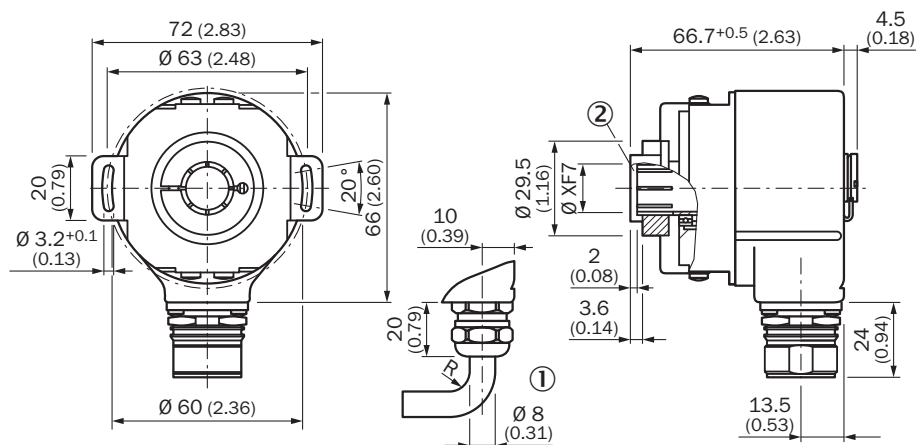

Dimensions in mm (inch)

General tolerances according to DIN ISO 2768-mk

① R = min. bending radius 40 mm

② Insertion depth of mounting shaft min. 15 mm

## Anschlussbelegung



PIN	Wire colors (cable connection)	SignalBinary	SignalGray	SignalBCD	
1	Violet	$2^0$	$G^0$	$2^0 \text{ v. } 10^0$	-
2	White/brown	$2^1$	$G^1$	$2^1 \text{ v. } 10^0$	-
3	White/green	$2^2$	$G^2$	$2^2 \text{ v. } 10^0$	-
4	White/yellow	$2^3$	$G^3$	$2^3 \text{ v. } 10^0$	-
5	White/grey	$2^4$	$G^4$	$2^0 \text{ v. } 10^1$	-
6	White/pink	$2^5$	$G^5$	$2^1 \text{ v. } 10^1$	-
7	White/blue	$2^6$	$G^6$	$2^2 \text{ v. } 10^1$	-
8	White/red	$2^7$	$G^7$	$2^3 \text{ v. } 10^1$	-
9	White/black	$2^8$	$G^8$	$2^0 \text{ v. } 10^2$	-
10	Brown/green	$2^9$	$G^9$	$2^1 \text{ v. } 10^2$	-
11	Brown/yellow	$2^{10}$	$G^{10}$	$2^2 \text{ v. } 10^2$	-
12	Brown/gray	$2^{11}$	$G^{11}$	$2^3 \text{ v. } 10^2$	-
13	Brown/pink	$2^{12}$	$G^{12}$	$2^0 \text{ v. } 10^3$	-
14	Brown/blue	$2^{13}$	$G^{13}$	$2^1 \text{ v. } 10^3$	-
15	Brown/red	$2^{14}$	$G^{14}$	$2^2 \text{ v. } 10^3$	-
16	Green	Parity		Parity	
17	Pink		Store		-
18	Yellow		Enable		-
19	Brown		CW/CCW (V/R)		-
*	Gray		SET		-
20	Blue		GND		-
21	Red		$U_S$		-

### Diagrams









### Diagrams Moment of inertia of the rotor



## Recommended accessories

Other models and accessories → [www.sick.com/ARS60](http://www.sick.com/ARS60)

	Brief description	Type	part no.
connectors and cables			
	<ul style="list-style-type: none"> <li><b>Description:</b> Parallel, shielded</li> <li><b>Connection type head A:</b> Flying leads</li> <li><b>Connection type head B:</b> Flying leads</li> <li><b>Signal type:</b> Parallel</li> <li><b>Items supplied:</b> By the meter</li> <li><b>Cable:</b> 22-wire, PUR, halogen-free</li> </ul>	LTG-2622-MW	6027532
	<ul style="list-style-type: none"> <li><b>Description:</b> SSI, shielded</li> <li><b>Connection type head A:</b> Female connector, M23, 21-pin, straight, A-coded</li> <li><b>Signal type:</b> SSI</li> <li><b>Connection systems:</b> Crimp contacts</li> </ul>	DOS-2321-G	6027539
	<ul style="list-style-type: none"> <li><b>Description:</b> Parallel, shielded</li> <li><b>Connection type head A:</b> Female connector, M23, 21-pin, straight</li> <li><b>Connection type head B:</b> Flying leads</li> <li><b>Signal type:</b> Parallel</li> <li><b>Cable:</b> 1.5 m, 22-wire, PUR, halogen-free</li> <li><b>Application:</b> Zones with oils and lubricants</li> </ul>	DOL-2321-G1M5PA4	2029218
	<ul style="list-style-type: none"> <li><b>Description:</b> Parallel, shielded</li> <li><b>Connection type head A:</b> Female connector, M23, 21-pin, straight</li> <li><b>Connection type head B:</b> Flying leads</li> <li><b>Signal type:</b> Parallel</li> <li><b>Cable:</b> 3 m, 22-wire, PUR, halogen-free</li> <li><b>Application:</b> Zones with oils and lubricants</li> </ul>	DOL-2321-G03MPA4	2029219
	<ul style="list-style-type: none"> <li><b>Description:</b> Parallel, shielded</li> <li><b>Connection type head A:</b> Female connector, M23, 21-pin, straight</li> <li><b>Connection type head B:</b> Flying leads</li> <li><b>Signal type:</b> Parallel</li> <li><b>Cable:</b> 5 m, 22-wire, PUR, halogen-free</li> <li><b>Application:</b> Zones with oils and lubricants</li> </ul>	DOL-2321-G05MPA4	2029220
	<ul style="list-style-type: none"> <li><b>Description:</b> Parallel, shielded</li> <li><b>Connection type head A:</b> Female connector, M23, 21-pin, straight</li> <li><b>Connection type head B:</b> Flying leads</li> <li><b>Signal type:</b> Parallel</li> <li><b>Cable:</b> 10 m, 22-wire, PUR, halogen-free</li> <li><b>Application:</b> Zones with oils and lubricants</li> </ul>	DOL-2321-G10MPA4	2029221
	<ul style="list-style-type: none"> <li><b>Description:</b> Parallel, shielded</li> <li><b>Connection type head A:</b> Female connector, M23, 21-pin, straight</li> <li><b>Connection type head B:</b> Flying leads</li> <li><b>Signal type:</b> Parallel</li> <li><b>Cable:</b> 20 m, 22-wire, PUR, halogen-free</li> <li><b>Application:</b> Zones with oils and lubricants</li> </ul>	DOL-2321-G20MPA4	2029222

	Brief description	Type	part no.
shaft adaptation			
	<ul style="list-style-type: none"> <li><b>Product segment:</b> Shaft adaptation</li> <li><b>Product:</b> Collets</li> <li><b>Description:</b> Collet for through hollow shaft, shaft diameter 6 mm, outer diameter 14 mm</li> </ul>	SPZ-006-AD-D	2029192
	<ul style="list-style-type: none"> <li><b>Product segment:</b> Shaft adaptation</li> <li><b>Product:</b> Collets</li> <li><b>Description:</b> Collet for through hollow shaft, shaft diameter 1/4" (6.35 mm), outer diameter 14 mm</li> </ul>	SPZ-1E4-AD-D	2029193
	<ul style="list-style-type: none"> <li><b>Product segment:</b> Shaft adaptation</li> <li><b>Product:</b> Collets</li> <li><b>Description:</b> Collet for through hollow shaft, shaft diameter 8 mm, outer diameter 14 mm</li> </ul>	SPZ-008-AD-D	2029194
	<ul style="list-style-type: none"> <li><b>Product segment:</b> Shaft adaptation</li> <li><b>Product:</b> Collets</li> <li><b>Description:</b> Collet for through hollow shaft, shaft diameter 3/8" (9.525 mm), outer diameter 14 mm</li> </ul>	SPZ-3E8-AD-D	2029195
	<ul style="list-style-type: none"> <li><b>Product segment:</b> Shaft adaptation</li> <li><b>Product:</b> Collets</li> <li><b>Description:</b> Collet for through hollow shaft, shaft diameter 10 mm, outer diameter 14 mm</li> </ul>	SPZ-010-AD-D	2029196
	<ul style="list-style-type: none"> <li><b>Product segment:</b> Shaft adaptation</li> <li><b>Product:</b> Collets</li> <li><b>Description:</b> Collet for through hollow shaft, shaft diameter 12 mm, outer diameter 14 mm</li> </ul>	SPZ-012-AD-D	2029197
	<ul style="list-style-type: none"> <li><b>Product segment:</b> Shaft adaptation</li> <li><b>Product:</b> Collets</li> <li><b>Description:</b> Collet for through hollow shaft, shaft diameter 1/2" (12.7 mm), outer diameter 14 mm</li> </ul>	SPZ-1E2-AD-D	2029198

## SICK AT A GLANCE

SICK is one of the leading manufacturers of intelligent sensors and sensor solutions for industrial applications. A unique range of products and services creates the perfect basis for controlling processes securely and efficiently, protecting individuals from accidents and preventing damage to the environment.

We have extensive experience in a wide range of industries and understand their processes and requirements. With intelligent sensors, we can deliver exactly what our customers need. In application centers in Europe, Asia and North America, system solutions are tested and optimized in accordance with customer specifications. All this makes us a reliable supplier and development partner.

Comprehensive services complete our offering: SICK LifeTime Services provide support throughout the machine life cycle and ensure safety and productivity.

For us, that is “Sensor Intelligence.”

## WORLDWIDE PRESENCE:

Contacts and other locations –[www.sick.com](http://www.sick.com)