



# CS84-N1112

CS8

COLOR SENSORS

**SICK**  
Sensor Intelligence.



Illustration may differ



## Ordering information

Type	part no.
CS84-N1112	1028230

Other models and accessories → [www.sick.com/CS8](http://www.sick.com/CS8)

## Detailed technical data

### Features

<b>Housing design</b>	Middle
<b>Dimensions (W x H x D)</b>	30.4 mm x 80 mm x 53 mm
<b>Light source</b>	LED, RGB <sup>1)</sup>
<b>Light spot size</b>	2 mm x 4 mm
<b>Light spot direction</b>	Vertical
<b>Wave length</b>	640 nm, 525 nm, 470 nm
<b>Sensing distance</b>	≤ 12.5 mm <sup>2)</sup>
<b>Sensing distance tolerance</b>	± 3 mm
<b>Adjustment</b>	Teach-in button
<b>Teach-in mode</b>	Static 1-point teach-in

<sup>1)</sup> Average service life: 100,000 h at T<sub>U</sub> = +25 °C.

<sup>2)</sup> From leading edge of lens.

### Electronics

<b>Supply voltage</b>	10 V DC ... 30 V DC <sup>1)</sup>
<b>Ripple</b>	< 5 V <sub>pp</sub> <sup>2)</sup>
<b>Current consumption</b>	< 120 mA <sup>3)</sup>
<b>Switching frequency</b>	0.5 kHz <sup>4)</sup>

<sup>1)</sup> Limit values when operated in short-circuit protected network: max. 8 A.

<sup>2)</sup> May not fall below or exceed U<sub>V</sub> tolerances.

<sup>3)</sup> Without load.

<sup>4)</sup> With light/dark ratio 1:1.

<sup>5)</sup> At 24 V.

<sup>6)</sup> AT > 200 μs.

<sup>7)</sup> Reference voltage DC 32 V.

	1 kHz 3.5 kHz Adjustable
<b>Response time</b>	1,000 μs 500 μs 145 μs
<b>Switching output</b>	NPN
<b>Switching output (voltage)</b>	NPN: HIGH = approx. $U_V$ / LOW $\leq 2$ V
<b>Output (channel)</b>	4 colors
<b>Output current <math>I_{max}</math></b>	100 mA <sup>5)</sup>
<b>Input, teach-in (ET)</b>	NPN Teach: $U < 2$ V Run: $U = 10$ V ... $< U_V$
<b>Input, blanking input (AT)</b>	NPN Blanked: $U < 2$ V Free-running: $U > 10$ V ... $< U_V$ <sup>6)</sup>
<b>Retention time (ET)</b>	25 ms, non-volatile memory
<b>Time delay</b>	Deactivation delay 20 ms, shiftable
<b>Protection class</b>	II <sup>7)</sup>
<b>Circuit protection</b>	$U_V$ connections, reverse polarity protected Output Q short-circuit protected Interference pulse suppression
<b>Connection type</b>	Male connector M12, 8-pin

1) Limit values when operated in short-circuit protected network: max. 8 A.

2) May not fall below or exceed  $U_V$  tolerances.

3) Without load.

4) With light/dark ratio 1:1.

5) At 24 V.

6)  $AT > 200$  μs.

7) Reference voltage DC 32 V.

## Mechanics

<b>Housing material</b>	Zinc diecast
<b>Weight</b>	400 g

## Ambient data

<b>Ambient operating temperature</b>	-10 °C ... +55 °C
<b>Ambient temperature, storage</b>	-20 °C ... +75 °C
<b>Shock load</b>	According to IEC 60068
<b>Enclosure rating</b>	IP67
<b>UL File No.</b>	NRKH.E181493 & NRKH7.E181493

## Certificates

<b>EU declaration of conformity</b>	✓
<b>UK declaration of conformity</b>	✓
<b>ACMA declaration of conformity</b>	✓

Moroccan declaration of conformity	✓
China RoHS	✓
cULus certificate	✓

### Classifications

<b>ECLASS 5.0</b>	27270907
<b>ECLASS 5.1.4</b>	27270907
<b>ECLASS 6.0</b>	27270907
<b>ECLASS 6.2</b>	27270907
<b>ECLASS 7.0</b>	27270907
<b>ECLASS 8.0</b>	27270907
<b>ECLASS 8.1</b>	27270907
<b>ECLASS 9.0</b>	27270907
<b>ECLASS 10.0</b>	27270907
<b>ECLASS 11.0</b>	27270907
<b>ECLASS 12.0</b>	27270907
<b>ETIM 5.0</b>	EC001817
<b>ETIM 6.0</b>	EC001817
<b>ETIM 7.0</b>	EC001817
<b>ETIM 8.0</b>	EC001817
<b>UNSPSC 16.0901</b>	39121528

### Dimensional drawing

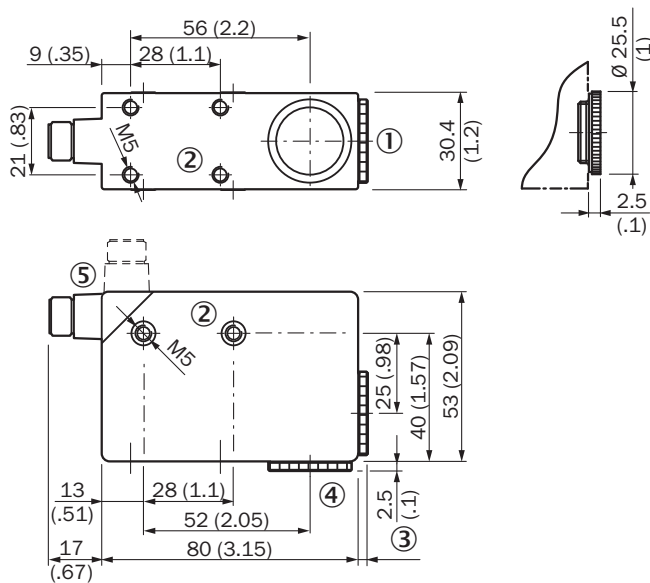

Dimensions in mm (inch)

- ① lens (light emission)
- ② M5 threaded mounting hole, 5.5 mm deep
- ③ see dimensional drawings of lenses
- ④ blind screw, can be replaced by lens

⑤ Connector M12 (rotatable up to 90°)

**Adjustments CS8-4**

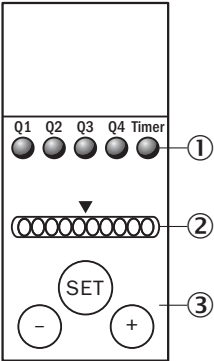

- ① Function signal indicators (yellow)
- ② bar graph (green), power-on left-hand LED
- ③ teach-in pushbutton / +/- pushbutton

**Connection diagram Cd-311**

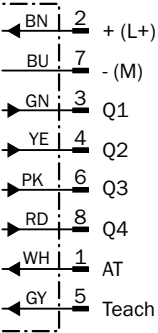

**Setting the switching threshold**

**1. Trigger teach-in**

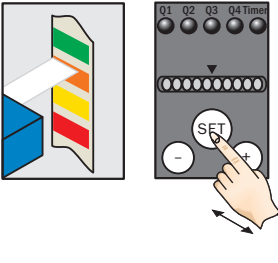

Position object in light field.  
 Press SET button > 1 s.

**2. Select color tolerance**

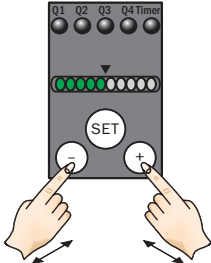

If requested adapt tolerance with  
 "+" button (more coarse) or  
 "-" button (more precise).  
 Press SET button > 1 s.

**3. Allocate channel to color**

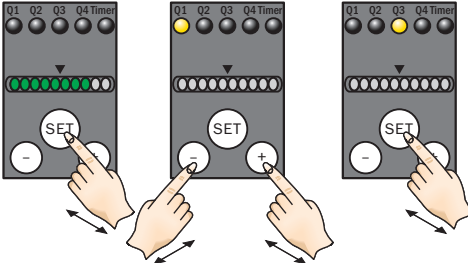

Allocate channel for color with  
 "+" button (Q1 to Q4) or  
 "-" button (Q4 to Q1).  
 Press SET button > 1 s.

Display of the color correspondence

**1. Full correspondence**

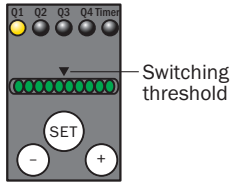

Color detected  
= Q active.

**2. Correspondence**

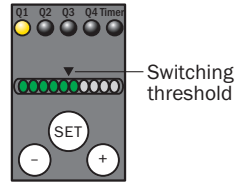

Color just detected  
= Q active.

**3. No correspondence**

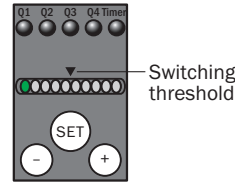

Color not detected  
= Q inactive.

**Special settings**

“Evaluation mode,” “Tolerance change during operation,” “Show quality,” “Time stage,” and “Output logic” can be set via a special menu (cf. appropriate operating instructions for the device).



> 1 s = enter/exit

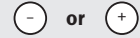



< 1 s = navigate





> 1 s = select/confirm

Recommended accessories

Other models and accessories → [www.sick.com/CS8](http://www.sick.com/CS8)

	Brief description	Type	part no.
Mounting systems			
	<ul style="list-style-type: none"> <li><b>Description:</b> Plate G for universal clamp bracket</li> <li><b>Material:</b> Steel</li> <li><b>Details:</b> Steel, zinc coated</li> <li><b>Items supplied:</b> Universal clamp (2022726), mounting hardware</li> <li><b>Usable for:</b> W34, LUT3, KT5-2, KT10, CS8, W24-2, KT8, KT8</li> </ul>	BEF-KHS-G01	2022464
	<ul style="list-style-type: none"> <li><b>Description:</b> Plate K for universal clamp bracket</li> <li><b>Material:</b> Steel</li> <li><b>Details:</b> Steel, zinc coated</li> <li><b>Items supplied:</b> Universal clamp (2022726), mounting hardware</li> <li><b>Usable for:</b> W11-2, W12-3, W14-2, W18-3, W23-2, W24-2, W27-3, W30, W32, W34, W36, PL50A, PL80A, P250, UC12, LUT3, KT2, KT5-2, KT8, CS8, DT2, DS30, DS40, W12-2 Laser, W16, W26, KT5</li> </ul>	BEF-KHS-K01	2022718

	Brief description	Type	part no.
connectors and cables			
	<ul style="list-style-type: none"> <li><b>Description:</b> Unshielded</li> <li><b>Connection type head A:</b> Female connector, M12, 8-pin, straight, A-coded</li> <li><b>Connection systems:</b> Screw-type terminals</li> <li><b>Permitted cross-section:</b> 0.25 mm<sup>2</sup> ... 0.5 mm<sup>2</sup></li> </ul>	DOS-1208-G	6028422
	<ul style="list-style-type: none"> <li><b>Description:</b> Shielded</li> <li><b>Connection type head A:</b> Female connector, M12, 8-pin, straight, A-coded</li> <li><b>Connection systems:</b> Screw-type terminals</li> <li><b>Permitted cross-section:</b> 0.25 mm<sup>2</sup> ... 0.5 mm<sup>2</sup></li> </ul>	DOS-1208-GA	6028369
	<ul style="list-style-type: none"> <li><b>Description:</b> Sensor/actuator cable, shielded</li> <li><b>Connection type head A:</b> Female connector, M12, 8-pin, straight, A-coded</li> <li><b>Connection type head B:</b> Flying leads</li> <li><b>Signal type:</b> Sensor/actuator cable</li> <li><b>Cable:</b> 2 m, 8-wire, PVC</li> <li><b>Application:</b> Uncontaminated zones, Zones with chemicals</li> </ul>	YF2A28-020VA6XLEAX	2096243
	<ul style="list-style-type: none"> <li><b>Description:</b> Sensor/actuator cable, shielded</li> <li><b>Connection type head A:</b> Female connector, M12, 8-pin, straight, A-coded</li> <li><b>Connection type head B:</b> Flying leads</li> <li><b>Signal type:</b> Sensor/actuator cable</li> <li><b>Cable:</b> 5 m, 8-wire, PVC</li> <li><b>Application:</b> Uncontaminated zones, Zones with chemicals</li> </ul>	YF2A28-050VA6XLEAX	2096244
	<ul style="list-style-type: none"> <li><b>Description:</b> Sensor/actuator cable, shielded</li> <li><b>Connection type head A:</b> Female connector, M12, 8-pin, angled, A-coded</li> <li><b>Connection type head B:</b> Flying leads</li> <li><b>Signal type:</b> Sensor/actuator cable</li> <li><b>Cable:</b> 2 m, 8-wire, PVC</li> <li><b>Application:</b> Uncontaminated zones, Zones with chemicals</li> </ul>	YG2A28-020VA6XLEAX	2096218
	<ul style="list-style-type: none"> <li><b>Description:</b> Sensor/actuator cable, shielded</li> <li><b>Connection type head A:</b> Female connector, M12, 8-pin, angled, A-coded</li> <li><b>Connection type head B:</b> Flying leads</li> <li><b>Signal type:</b> Sensor/actuator cable</li> <li><b>Cable:</b> 5 m, 8-wire, PVC</li> <li><b>Application:</b> Uncontaminated zones, Zones with chemicals</li> </ul>	YG2A28-050VA6XLEAX	2096219
	<ul style="list-style-type: none"> <li><b>Description:</b> Sensor/actuator cable, shielded</li> <li><b>Connection type head A:</b> Female connector, M12, 8-pin, angled, A-coded</li> <li><b>Connection type head B:</b> Flying leads</li> <li><b>Signal type:</b> Sensor/actuator cable</li> <li><b>Cable:</b> 0.5 m, 8-wire, PVC</li> <li><b>Application:</b> Uncontaminated zones, Zones with chemicals</li> </ul>	YG2A28-C50VA6XLEAX	2145694
	<ul style="list-style-type: none"> <li><b>Description:</b> Sensor/actuator cable, shielded</li> <li><b>Connection type head A:</b> Female connector, M12, 8-pin, straight, A-coded</li> <li><b>Connection type head B:</b> Flying leads</li> <li><b>Signal type:</b> Sensor/actuator cable</li> <li><b>Cable:</b> 3 m, 8-wire, PVC</li> <li><b>Application:</b> Uncontaminated zones, Zones with chemicals</li> </ul>	YF2A28-030VA6XLEAX	2145695
	<ul style="list-style-type: none"> <li><b>Description:</b> Sensor/actuator cable, shielded</li> <li><b>Connection type head A:</b> Female connector, M12, 8-pin, angled, A-coded</li> <li><b>Connection type head B:</b> Flying leads</li> <li><b>Signal type:</b> Sensor/actuator cable</li> <li><b>Cable:</b> 0.6 m, 8-wire, PVC</li> <li><b>Application:</b> Uncontaminated zones, Zones with chemicals</li> </ul>	YG2A28-C60VA6XLEAX	2145388
	<ul style="list-style-type: none"> <li><b>Description:</b> Sensor/actuator cable, shielded</li> <li><b>Connection type head A:</b> Female connector, M12, 8-pin, angled, A-coded</li> <li><b>Connection type head B:</b> Flying leads</li> <li><b>Signal type:</b> Sensor/actuator cable</li> <li><b>Cable:</b> 1 m, 8-wire, PVC</li> <li><b>Application:</b> Uncontaminated zones, Zones with chemicals</li> </ul>	YG2A28-010VA6XLEAX	2145389
	<ul style="list-style-type: none"> <li><b>Description:</b> Sensor/actuator cable, shielded</li> <li><b>Connection type head A:</b> Female connector, M12, 8-pin, angled, A-coded</li> <li><b>Connection type head B:</b> Flying leads</li> <li><b>Signal type:</b> Sensor/actuator cable</li> <li><b>Cable:</b> 10 m, 8-wire, PVC</li> </ul>	YG2A28-100VA6XLEAX	2145391

	Brief description	Type	part no.
	<ul style="list-style-type: none"> <li>• <b>Application:</b> Untaminated zones, Zones with chemicals</li> <li>• <b>Description:</b> Sensor/actuator cable, shielded</li> <li>• <b>Connection type head A:</b> Female connector, M12, 8-pin, angled, A-coded</li> <li>• <b>Connection type head B:</b> Flying leads</li> <li>• <b>Signal type:</b> Sensor/actuator cable</li> <li>• <b>Cable:</b> 3 m, 8-wire, PVC</li> <li>• <b>Application:</b> Untaminated zones, Zones with chemicals</li> </ul>	YG2A28-030VA6XLEAX	2145390
	<ul style="list-style-type: none"> <li>• <b>Description:</b> Sensor/actuator cable, shielded</li> <li>• <b>Connection type head A:</b> Female connector, M12, 8-pin, straight, A-coded</li> <li>• <b>Connection type head B:</b> Flying leads</li> <li>• <b>Signal type:</b> Sensor/actuator cable</li> <li>• <b>Cable:</b> 0.6 m, 8-wire, PVC</li> <li>• <b>Application:</b> Untaminated zones, Zones with chemicals</li> </ul>	YF2A28-C60VA6XLEAX	2145385
	<ul style="list-style-type: none"> <li>• <b>Description:</b> Sensor/actuator cable, shielded</li> <li>• <b>Connection type head A:</b> Female connector, M12, 8-pin, straight, A-coded</li> <li>• <b>Connection type head B:</b> Flying leads</li> <li>• <b>Signal type:</b> Sensor/actuator cable</li> <li>• <b>Cable:</b> 1 m, 8-wire, PVC</li> <li>• <b>Application:</b> Untaminated zones, Zones with chemicals</li> </ul>	YF2A28-010VA6XLEAX	2145386

## SICK AT A GLANCE

SICK is one of the leading manufacturers of intelligent sensors and sensor solutions for industrial applications. A unique range of products and services creates the perfect basis for controlling processes securely and efficiently, protecting individuals from accidents and preventing damage to the environment.

We have extensive experience in a wide range of industries and understand their processes and requirements. With intelligent sensors, we can deliver exactly what our customers need. In application centers in Europe, Asia and North America, system solutions are tested and optimized in accordance with customer specifications. All this makes us a reliable supplier and development partner.

Comprehensive services complete our offering: SICK LifeTime Services provide support throughout the machine life cycle and ensure safety and productivity.

For us, that is “Sensor Intelligence.”

## WORLDWIDE PRESENCE:

Contacts and other locations –[www.sick.com](http://www.sick.com)