



CS81-N3612

CS8

COLOR SENSORS

SICK
Sensor Intelligence.



Illustration may differ

Ordering information

Type	part no.
CS81-N3612	1028229

Included in delivery: Lens, TW60 (1)

Other models and accessories → www.sick.com/CS8

Detailed technical data

Features

Housing design	Middle
Dimensions (W x H x D)	30.4 mm x 80 mm x 53 mm
Light source	LED, RGB ¹⁾
Light spot size	13 mm x 13 mm
Wave length	640 nm, 525 nm, 470 nm
Sensing distance	≤ 60 mm ²⁾
Sensing distance tolerance	± 9 mm
Adjustment	Teach-in button
Teach-in mode	Static 1-point teach-in

¹⁾ Average service life: 100,000 h at T_J = +25 °C.

²⁾ From leading edge of lens.

Electronics

Supply voltage	10 V DC ... 30 V DC ¹⁾
Ripple	< 5 V _{pp} ²⁾
Current consumption	< 120 mA ³⁾
Switching frequency	1 kHz ⁴⁾ 3 kHz 6 kHz Adjustable
Response time	500 μs

¹⁾ Limit values when operated in short-circuit protected network: max. 8 A.

²⁾ May not fall below or exceed U_y tolerances.

³⁾ Without load.

⁴⁾ With light/dark ratio 1:1.

⁵⁾ At 24 V.

⁶⁾ AT > 200 μs.

⁷⁾ Reference voltage DC 32 V.

	160 µs
	85 µs
Switching output	NPN
Switching output (voltage)	NPN: HIGH = approx. U_V / LOW \leq 2 V
Output (channel)	1 color
Output current I_{max}	100 mA ⁵⁾
Input, teach-in (ET)	NPN Teach: $U < 2$ V Run: $U = 10$ V ... $< U_V$
Input, blanking input (AT)	NPN Blanked: $U < 2$ V Free-running: $U > 10$ V ... $< U_V$ ⁶⁾
Retention time (ET)	25 ms, non-volatile memory
Time delay	Deactivation delay 20 ms, shiftable
Protection class	II ⁷⁾
Circuit protection	U_V connections, reverse polarity protected Output Q short-circuit protected Interference pulse suppression
Connection type	Plug, M12, 5-pin

1) Limit values when operated in short-circuit protected network: max. 8 A.

2) May not fall below or exceed U_V tolerances.

3) Without load.

4) With light/dark ratio 1:1.

5) At 24 V.

6) AT > 200 µs.

7) Reference voltage DC 32 V.

Mechanics

Housing material	Zinc diecast
Weight	400 g

Ambient data

Ambient operating temperature	-10 °C ... +55 °C
Ambient temperature, storage	-20 °C ... +75 °C
Shock load	According to IEC 60068
Enclosure rating	IP67
UL File No.	NRKH.E181493 & NRKH7.E181493

Classifications

ECLASS 5.0	27270907
ECLASS 5.1.4	27270907
ECLASS 6.0	27270907
ECLASS 6.2	27270907
ECLASS 7.0	27270907
ECLASS 8.0	27270907
ECLASS 8.1	27270907

ECLASS 9.0	27270907
ECLASS 10.0	27270907
ECLASS 11.0	27270907
ECLASS 12.0	27270907
ETIM 5.0	EC001817
ETIM 6.0	EC001817
ETIM 7.0	EC001817
ETIM 8.0	EC001817
UNSPSC 16.0901	39121528

Dimensional drawing

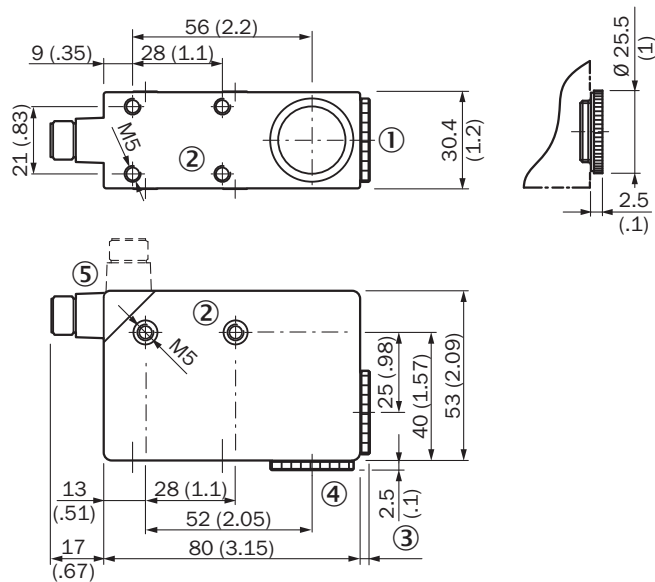

Dimensions in mm (inch)

- ① lens (light emission)
- ② M5 threaded mounting hole, 5.5 mm deep
- ③ see dimensional drawings of lenses
- ④ blind screw, can be replaced by lens
- ⑤ Connector M12 (rotatable up to 90°)

Adjustments CS8-1

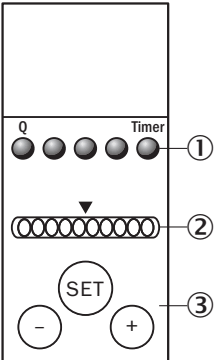

- ① Function signal indicators (yellow)
- ② bar graph (green), power-on left-hand LED
- ③ teach-in pushbutton / +/- pushbutton

Connection diagram Cd-313

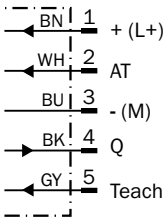

Display of the color correspondence

1. Full correspondence

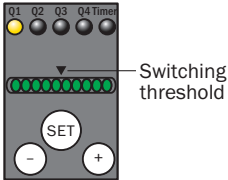

Color detected
 = Q active.

2. Correspondence

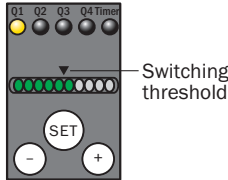

Color just detected
 = Q active.

3. No correspondence

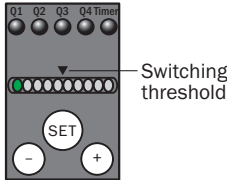

Color not detected
 = Q inactive.

Special settings

“Evaluation mode,” “Tolerance change during operation,” “Show quality,” “Time stage,” and “Output logic” can be set via a special menu (cf. appropriate operating instructions for the device).

- and +
- > 1 s = enter/exit
- or +
- < 1 s = navigate
- SET
- > 1 s = select/confirm

Setting the switching threshold

1. Trigger teach-in

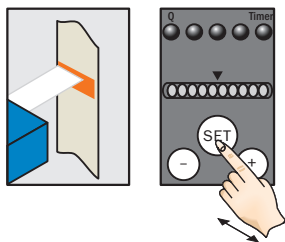

Position object in light field.
 Press SET button > 1 s.

2. Select color tolerance

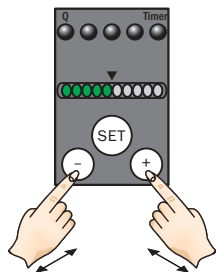

If necessary adapt tolerance with
 “+” button (more coarse) or
 “-” button (more precise).

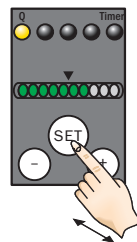

3. Confirm teach-in





Press SET button > 1 s.
 Color correspondence is
 visualized via bar graph display.

Recommended accessories

Other models and accessories → www.sick.com/CS8

	Brief description	Type	part no.
Mounting systems			
	<ul style="list-style-type: none"> Description: Plate G for universal clamp bracket Material: Steel Details: Steel, zinc coated Items supplied: Universal clamp (2022726), mounting hardware Usable for: W34, LUT3, KT5-2, KT10, CS8, W24-2, KT8, KT8 	BEF-KHS-G01	2022464
	<ul style="list-style-type: none"> Description: Plate K for universal clamp bracket Material: Steel Details: Steel, zinc coated Items supplied: Universal clamp (2022726), mounting hardware Usable for: W11-2, W12-3, W14-2, W18-3, W23-2, W24-2, W27-3, W30, W32, W34, W36, PL50A, PL80A, P250, UC12, LUT3, KT2, KT5-2, KT8, CS8, DT2, DS30, DS40, W12-2 Laser, W16, W26, KT5 	BEF-KHS-K01	2022718

	Brief description	Type	part no.
connectors and cables			
	<ul style="list-style-type: none"> Description: Unshielded Connection type head A: Female connector, M12, 5-pin, straight, A-coded Connection systems: Screw-type terminals Permitted cross-section: ≤ 0.75 mm² 	DOS-1205-G	6009719
	<ul style="list-style-type: none"> Description: Unshielded Connection type head A: Female connector, M12, 5-pin, angled, A-coded Connection systems: Screw-type terminals Permitted cross-section: ≤ 0.75 mm² 	DOS-1205-W	6009720
	<ul style="list-style-type: none"> Description: Sensor/actuator cable, unshielded Connection type head A: Female connector, M12, 5-pin, angled, A-coded Connection type head B: Flying leads Signal type: Sensor/actuator cable Cable: 2 m, 5-wire, PVC Application: Uncontaminated zones, Zones with chemicals 	YG2A15-020VB5XLEAX	2096215
	<ul style="list-style-type: none"> Description: Sensor/actuator cable, unshielded Connection type head A: Female connector, M12, 5-pin, angled, A-coded Connection type head B: Flying leads Signal type: Sensor/actuator cable Cable: 5 m, 5-wire, PVC Application: Uncontaminated zones, Zones with chemicals 	YG2A15-050VB5XLEAX	2096216
	<ul style="list-style-type: none"> Description: Sensor/actuator cable, unshielded Connection type head A: Female connector, M12, 5-pin, angled, A-coded Connection type head B: Flying leads Signal type: Sensor/actuator cable Cable: 10 m, 5-wire, PVC Application: Uncontaminated zones, Zones with chemicals 	YG2A15-100VB5XLEAX	2096217
	<ul style="list-style-type: none"> Description: Sensor/actuator cable, unshielded Connection type head A: Female connector, M12, 5-pin, straight, A-coded Connection type head B: Flying leads Signal type: Sensor/actuator cable Cable: 2 m, 5-wire, PVC Application: Uncontaminated zones, Zones with chemicals 	YF2A15-020VB5XLEAX	2096239
	<ul style="list-style-type: none"> Description: Sensor/actuator cable, unshielded Connection type head A: Female connector, M12, 5-pin, straight, A-coded Connection type head B: Flying leads Signal type: Sensor/actuator cable Cable: 5 m, 5-wire, PVC Application: Uncontaminated zones, Zones with chemicals 	YF2A15-050VB5XLEAX	2096240
	<ul style="list-style-type: none"> Description: Sensor/actuator cable, unshielded Connection type head A: Female connector, M12, 5-pin, straight, A-coded Connection type head B: Flying leads Signal type: Sensor/actuator cable Cable: 10 m, 5-wire, PVC Application: Uncontaminated zones, Zones with chemicals 	YF2A15-100VB5XLEAX	2096241
	<ul style="list-style-type: none"> Description: Sensor/actuator cable, unshielded Connection type head A: Female connector, M12, 5-pin, angled, A-coded Connection type head B: Flying leads Signal type: Sensor/actuator cable Cable: 0.6 m, 5-wire, PVC Application: Uncontaminated zones, Zones with chemicals 	YG2A15-C60VB5XLEAX	2145573
	<ul style="list-style-type: none"> Description: Sensor/actuator cable, unshielded Connection type head A: Female connector, M12, 5-pin, angled, A-coded Connection type head B: Flying leads Signal type: Sensor/actuator cable Cable: 1 m, 5-wire, PVC Application: Uncontaminated zones, Zones with chemicals 	YG2A15-010VB5XLEAX	2145574
	<ul style="list-style-type: none"> Description: Sensor/actuator cable, unshielded Connection type head A: Female connector, M12, 5-pin, angled, A-coded Connection type head B: Flying leads Signal type: Sensor/actuator cable Cable: 3 m, 5-wire, PVC 	YG2A15-030VB5XLEAX	2145575

	Brief description	Type	part no.
	<ul style="list-style-type: none"> • Application: Untaminated zones, Zones with chemicals • Description: Sensor/actuator cable, unshielded • Connection type head A: Female connector, M12, 5-pin, straight, A-coded • Connection type head B: Flying leads • Signal type: Sensor/actuator cable • Cable: 0.6 m, 5-wire, PVC • Application: Untaminated zones, Zones with chemicals 	<p>YF2A15-C60VB5XLEAX</p>	<p>2145570</p>
	<ul style="list-style-type: none"> • Description: Sensor/actuator cable, unshielded • Connection type head A: Female connector, M12, 5-pin, straight, A-coded • Connection type head B: Flying leads • Signal type: Sensor/actuator cable • Cable: 3 m, 5-wire, PVC • Application: Untaminated zones, Zones with chemicals 	<p>YF2A15-030VB5XLEAX</p>	<p>2145572</p>

SICK AT A GLANCE

SICK is one of the leading manufacturers of intelligent sensors and sensor solutions for industrial applications. A unique range of products and services creates the perfect basis for controlling processes securely and efficiently, protecting individuals from accidents and preventing damage to the environment.

We have extensive experience in a wide range of industries and understand their processes and requirements. With intelligent sensors, we can deliver exactly what our customers need. In application centers in Europe, Asia and North America, system solutions are tested and optimized in accordance with customer specifications. All this makes us a reliable supplier and development partner.

Comprehensive services complete our offering: SICK LifeTime Services provide support throughout the machine life cycle and ensure safety and productivity.

For us, that is “Sensor Intelligence.”

WORLDWIDE PRESENCE:

Contacts and other locations –www.sick.com