



LUT1B-31325

LUT1

LUMINESCENCE SENSORS

SICK
Sensor Intelligence.



Illustration may differ



Ordering information

Type	part no.
LUT1B-31325	1027593

Other models and accessories → www.sick.com/LUT1

Detailed technical data

Features

Housing design	Middle
Dimensions (W x H x D)	23 mm x 70 mm x 47.5 mm
Light source	LED, visible blue light ¹⁾
Light emission	Long side
Light spot size	5 mm x 5 mm
Receiving filters	≤ 590 nm ²⁾
Wave length	470 nm
Working range	15 mm ... 60 mm
Sensing distance	≤ 50 mm ³⁾
Receiving range	590 nm ... 750 nm
Adjustment	Double teach-in button
Output function	Light switching

¹⁾ Average service life: 100,000 h at T_U = +25 °C.

²⁾ Filter blocks shorter wavelengths to suppress background luminescence.

³⁾ From leading edge of lens.

Electronics

Supply voltage	10 V DC ... 30 V DC ¹⁾
Ripple	< 5 V _{pp} ²⁾

¹⁾ Limit values when operated in short-circuit protected network: max. 8 A.

²⁾ May not fall below or exceed U_y tolerances.

³⁾ Without load.

⁴⁾ With light/dark ratio 1:1, without timer stage.

⁵⁾ Reference voltage DC 50 V.

Current consumption	< 40 mA ³⁾
Switching frequency	6 kHz ⁴⁾
Response time	85 µs
Switching output	PNP NPN
Switching output (voltage)	PNP: HIGH = $U_V \leq 2 \text{ V}$ / LOW approx. 0 V NPN: HIGH = approx. U_V / LOW $\leq 2 \text{ V}$
Switching mode	Light switching
Output current I_{max}	200 mA
Protection class	III ⁵⁾
Circuit protection	U_V connections, reverse polarity protected Output Q short-circuit protected Interference pulse suppression
Connection type	Plug, M12, 5-pin

1) Limit values when operated in short-circuit protected network: max. 8 A.

2) May not fall below or exceed U_V tolerances.

3) Without load.

4) With light/dark ratio 1:1, without timer stage.

5) Reference voltage DC 50 V.

Mechanics

Housing material	Zinc diecast
Weight	240 g

Ambient data

Ambient operating temperature	-20 °C ... +60 °C
Ambient temperature, storage	-40 °C ... +70 °C
Shock load	According to IEC 60068
Enclosure rating	IP67

Certificates

EU declaration of conformity	✓
UK declaration of conformity	✓
ACMA declaration of conformity	✓
Moroccan declaration of conformity	✓
China RoHS	✓

Classifications

ECLASS 5.0	27270908
ECLASS 5.1.4	27270908
ECLASS 6.0	27270908
ECLASS 6.2	27270908
ECLASS 7.0	27270908
ECLASS 8.0	27270908

ECLASS 8.1	27270908
ECLASS 9.0	27270908
ECLASS 10.0	27270908
ECLASS 11.0	27270908
ECLASS 12.0	27270908
ETIM 5.0	EC001822
ETIM 6.0	EC001822
ETIM 7.0	EC001822
ETIM 8.0	EC001822
UNSPSC 16.0901	39121528

Dimensional drawing

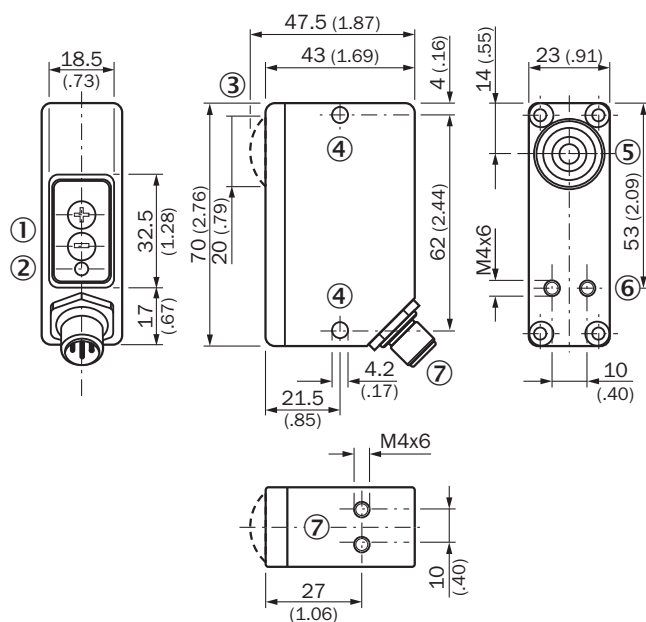

Dimensions in mm (inch)

- ① Control elements
- ② LED signal strength indicator
- ③ lens flush with device for LUT1B-12205
- ④ fixing hole
- ⑤ Optical axis
- ⑥ Threaded mounting hole
- ⑦ Male connector M12

Pinouts

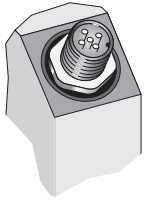

Adjustments

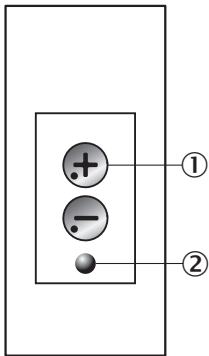

- ① Control elements
- ② LED signal strength indicator

Connection diagram

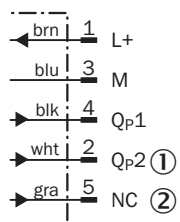

- ① Qp2 or control output
- ② NC or analog output

Sensing distance

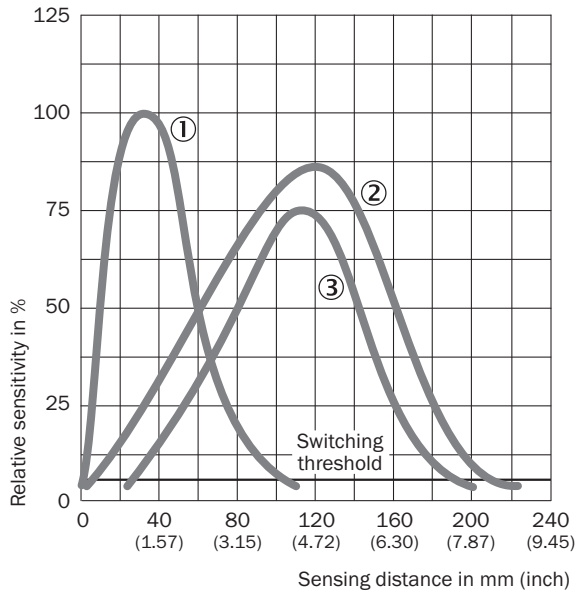

- ① LUT1B sensing distance 50 mm; scan material: acryl orange
- ② LUT1B sensing distance 150 mm; scan material: acryl orange
- ③ LUT1U sensing distance 150 mm; scan material: SICK Luminescence reference 100 %

Light spot size

Sensing distance 50 mm

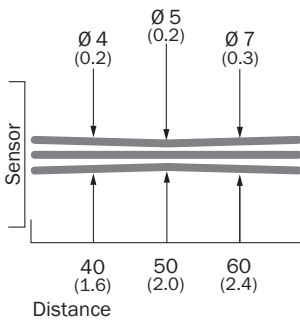

Sensing distance 80 mm

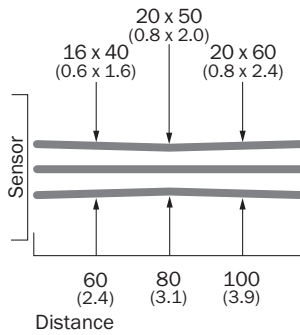

Sensing distance 150 mm

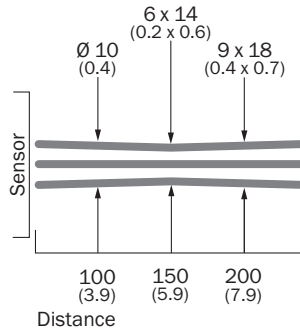

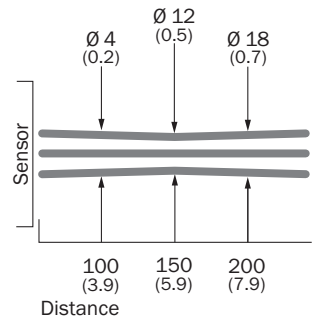

Sensing distance 150 mm





All dimensions in mm (inch)

Recommended accessories

Other models and accessories → www.sick.com/LUT1

	Brief description	Type	part no.
Commissioning aids and test equipment			
	<ul style="list-style-type: none"> Description: Writing chalk, red fluorescence 	LUM-KLK	1002959
	<ul style="list-style-type: none"> Description: Thick chalk, red fluorescent, 12 units 	LUM-FT	1004460

	Brief description	Type	part no.
connectors and cables			
	<ul style="list-style-type: none"> Description: Unshielded Connection type head A: Female connector, M12, 5-pin, straight, A-coded Connection systems: Screw-type terminals Permitted cross-section: ≤ 0.75 mm² 	DOS-1205-G	6009719
	<ul style="list-style-type: none"> Description: Unshielded Connection type head A: Female connector, M12, 5-pin, angled, A-coded Connection systems: Screw-type terminals Permitted cross-section: ≤ 0.75 mm² 	DOS-1205-W	6009720
	<ul style="list-style-type: none"> Description: Sensor/actuator cable, unshielded Connection type head A: Female connector, M12, 5-pin, angled, A-coded Connection type head B: Flying leads Signal type: Sensor/actuator cable Cable: 2 m, 5-wire, PVC Application: Untaminated zones, Zones with chemicals 	YG2A15-020VB5XLEAX	2096215
	<ul style="list-style-type: none"> Description: Sensor/actuator cable, unshielded Connection type head A: Female connector, M12, 5-pin, angled, A-coded Connection type head B: Flying leads Signal type: Sensor/actuator cable Cable: 5 m, 5-wire, PVC Application: Untaminated zones, Zones with chemicals 	YG2A15-050VB5XLEAX	2096216
	<ul style="list-style-type: none"> Description: Sensor/actuator cable, unshielded Connection type head A: Female connector, M12, 5-pin, angled, A-coded Connection type head B: Flying leads Signal type: Sensor/actuator cable Cable: 10 m, 5-wire, PVC Application: Untaminated zones, Zones with chemicals 	YG2A15-100VB5XLEAX	2096217
	<ul style="list-style-type: none"> Description: Sensor/actuator cable, unshielded Connection type head A: Female connector, M12, 5-pin, straight, A-coded Connection type head B: Flying leads Signal type: Sensor/actuator cable Cable: 2 m, 5-wire, PVC Application: Untaminated zones, Zones with chemicals 	YF2A15-020VB5XLEAX	2096239
	<ul style="list-style-type: none"> Description: Sensor/actuator cable, unshielded Connection type head A: Female connector, M12, 5-pin, straight, A-coded Connection type head B: Flying leads Signal type: Sensor/actuator cable Cable: 5 m, 5-wire, PVC Application: Untaminated zones, Zones with chemicals 	YF2A15-050VB5XLEAX	2096240
	<ul style="list-style-type: none"> Description: Sensor/actuator cable, unshielded Connection type head A: Female connector, M12, 5-pin, straight, A-coded Connection type head B: Flying leads Signal type: Sensor/actuator cable Cable: 10 m, 5-wire, PVC Application: Untaminated zones, Zones with chemicals 	YF2A15-100VB5XLEAX	2096241
	<ul style="list-style-type: none"> Description: Sensor/actuator cable, unshielded Connection type head A: Female connector, M12, 5-pin, angled, A-coded Connection type head B: Flying leads Signal type: Sensor/actuator cable Cable: 0.6 m, 5-wire, PVC Application: Untaminated zones, Zones with chemicals 	YG2A15-C60VB5XLEAX	2145573
	<ul style="list-style-type: none"> Description: Sensor/actuator cable, unshielded Connection type head A: Female connector, M12, 5-pin, angled, A-coded Connection type head B: Flying leads Signal type: Sensor/actuator cable Cable: 1 m, 5-wire, PVC Application: Untaminated zones, Zones with chemicals 	YG2A15-010VB5XLEAX	2145574
	<ul style="list-style-type: none"> Description: Sensor/actuator cable, unshielded Connection type head A: Female connector, M12, 5-pin, angled, A-coded Connection type head B: Flying leads Signal type: Sensor/actuator cable Cable: 3 m, 5-wire, PVC 	YG2A15-030VB5XLEAX	2145575

	Brief description	Type	part no.
	<ul style="list-style-type: none"> • Application: Uncontaminated zones, Zones with chemicals • Description: Sensor/actuator cable, unshielded • Connection type head A: Female connector, M12, 5-pin, straight, A-coded • Connection type head B: Flying leads • Signal type: Sensor/actuator cable • Cable: 0.6 m, 5-wire, PVC • Application: Uncontaminated zones, Zones with chemicals 	YF2A15-C60VB5XLEAX	2145570
	<ul style="list-style-type: none"> • Description: Sensor/actuator cable, unshielded • Connection type head A: Female connector, M12, 5-pin, straight, A-coded • Connection type head B: Flying leads • Signal type: Sensor/actuator cable • Cable: 3 m, 5-wire, PVC • Application: Uncontaminated zones, Zones with chemicals 	YF2A15-030VB5XLEAX	2145572

SICK AT A GLANCE

SICK is one of the leading manufacturers of intelligent sensors and sensor solutions for industrial applications. A unique range of products and services creates the perfect basis for controlling processes securely and efficiently, protecting individuals from accidents and preventing damage to the environment.

We have extensive experience in a wide range of industries and understand their processes and requirements. With intelligent sensors, we can deliver exactly what our customers need. In application centers in Europe, Asia and North America, system solutions are tested and optimized in accordance with customer specifications. All this makes us a reliable supplier and development partner.

Comprehensive services complete our offering: SICK LifeTime Services provide support throughout the machine life cycle and ensure safety and productivity.

For us, that is “Sensor Intelligence.”

WORLDWIDE PRESENCE:

Contacts and other locations –www.sick.com