



# LUT1B-12205

LUT1

LUMINESCENCE SENSORS

**SICK**  
Sensor Intelligence.



Illustration may differ



## Ordering information

Type	part no.
LUT1B-12205	1027497

Other models and accessories → [www.sick.com/LUT1](http://www.sick.com/LUT1)

## Detailed technical data

### Features

<b>Housing design</b>	Middle
<b>Dimensions (W x H x D)</b>	23 mm x 70 mm x 47.5 mm
<b>Light source</b>	LED, visible blue light <sup>1)</sup>
<b>Light emission</b>	Long side
<b>Light spot size</b>	10 mm x 70 mm
<b>Receiving filters</b>	≤ 590 nm <sup>2)</sup>
<b>Wave length</b>	470 nm
<b>Working range</b>	60 mm ... 100 mm
<b>Sensing distance</b>	70 mm ... 80 mm <sup>3)</sup>
<b>Receiving range</b>	590 nm ... 750 nm
<b>Adjustment</b>	Double teach-in button
<b>Output function</b>	Light switching

<sup>1)</sup> Average service life: 100,000 h at T<sub>J</sub> = +25 °C.

<sup>2)</sup> Filter blocks shorter wavelengths to suppress background luminescence.

<sup>3)</sup> From leading edge of lens.

### Electronics

<b>Supply voltage</b>	10 V DC ... 30 V DC <sup>1)</sup>
<b>Ripple</b>	< 5 V <sub>pp</sub> <sup>2)</sup>

<sup>1)</sup> Limit values when operated in short-circuit protected network: max. 8 A.

<sup>2)</sup> May not fall below or exceed U<sub>y</sub> tolerances.

<sup>3)</sup> Without load.

<sup>4)</sup> With light/dark ratio 1:1, without timer stage.

<sup>5)</sup> Only LUT1B-12205.

<sup>6)</sup> Reference voltage DC 50 V.

<b>Current consumption</b>	< 40 mA <sup>3)</sup>
<b>Switching frequency</b>	600 Hz <sup>4)</sup>
<b>Response time</b>	850 µs
<b>Switching output</b>	PNP
<b>Switching output (voltage)</b>	PNP: HIGH = $U_V \leq 2\text{ V}$ / LOW approx. 0 V
<b>Switching mode</b>	Light switching
<b>Analog output</b>	0.5 mA ... 10 mA <sup>5)</sup>
<b>Output current <math>I_{\text{max}}</math></b>	200 mA
<b>Protection class</b>	III <sup>6)</sup>
<b>Circuit protection</b>	$U_V$ connections, reverse polarity protected Output Q short-circuit protected Interference pulse suppression
<b>Connection type</b>	Plug, M12, 5-pin

1) Limit values when operated in short-circuit protected network: max. 8 A.

2) May not fall below or exceed  $U_V$  tolerances.

3) Without load.

4) With light/dark ratio 1:1, without timer stage.

5) Only LUT1B-12205.

6) Reference voltage DC 50 V.

## Mechanics

<b>Housing material</b>	Zinc diecast
<b>Weight</b>	240 g

## Ambient data

<b>Ambient operating temperature</b>	-20 °C ... +60 °C
<b>Ambient temperature, storage</b>	-40 °C ... +70 °C
<b>Shock load</b>	According to IEC 60068
<b>Enclosure rating</b>	IP67

## Certificates

<b>EU declaration of conformity</b>	✓
<b>UK declaration of conformity</b>	✓
<b>ACMA declaration of conformity</b>	✓
<b>Moroccan declaration of conformity</b>	✓
<b>China RoHS</b>	✓

## Classifications

<b>ECLASS 5.0</b>	27270908
<b>ECLASS 5.1.4</b>	27270908
<b>ECLASS 6.0</b>	27270908
<b>ECLASS 6.2</b>	27270908
<b>ECLASS 7.0</b>	27270908
<b>ECLASS 8.0</b>	27270908

<b>ECLASS 8.1</b>	27270908
<b>ECLASS 9.0</b>	27270908
<b>ECLASS 10.0</b>	27270908
<b>ECLASS 11.0</b>	27270908
<b>ECLASS 12.0</b>	27270908
<b>ETIM 5.0</b>	EC001822
<b>ETIM 6.0</b>	EC001822
<b>ETIM 7.0</b>	EC001822
<b>ETIM 8.0</b>	EC001822
<b>UNSPSC 16.0901</b>	39121528

Dimensional drawing

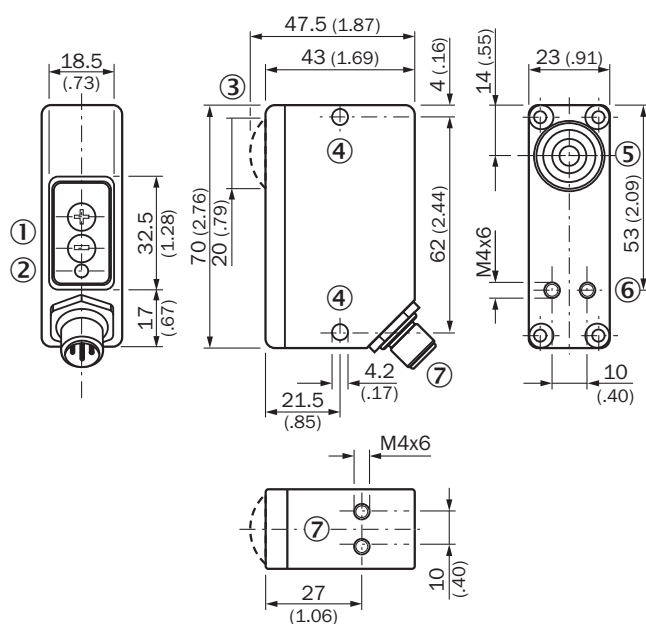

Dimensions in mm (inch)

- ① Control elements
- ② LED signal strength indicator
- ③ lens flush with device for LUT1B-12205
- ④ fixing hole
- ⑤ Optical axis
- ⑥ Threaded mounting hole
- ⑦ Male connector M12

## Pinouts

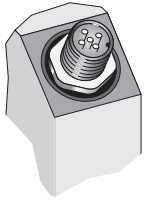

## Adjustments

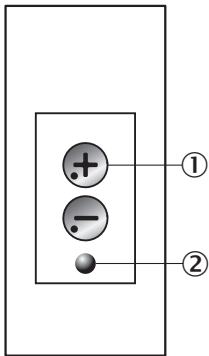

- ① Control elements
- ② LED signal strength indicator

## Connection diagram

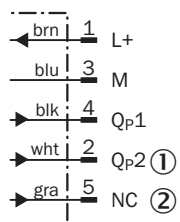

- ① Qp2 or control output
- ② NC or analog output

Sensing distance

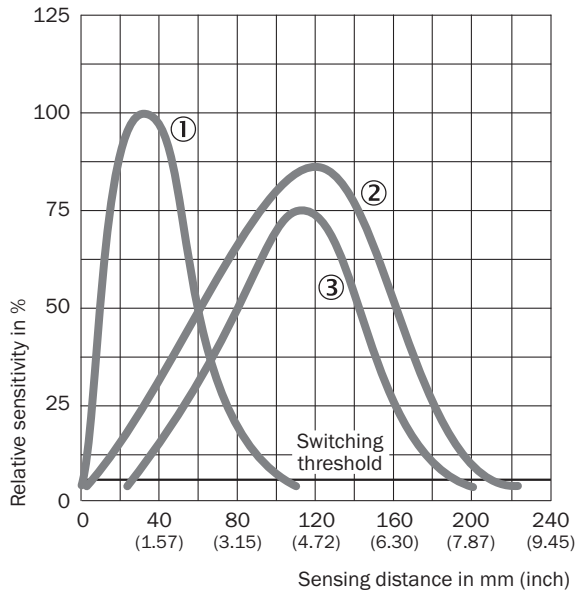

- ① LUT1B sensing distance 50 mm; scan material: acryl orange
- ② LUT1B sensing distance 150 mm; scan material: acryl orange
- ③ LUT1U sensing distance 150 mm; scan material: SICK Luminescence reference 100 %

Light spot size

Sensing distance 50 mm

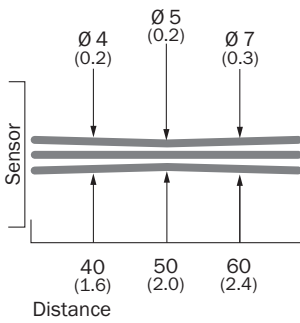

Sensing distance 80 mm

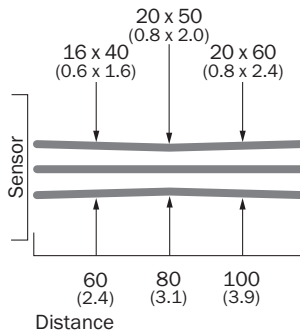

Sensing distance 150 mm

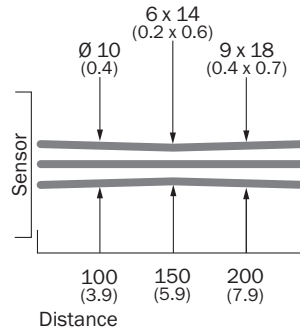

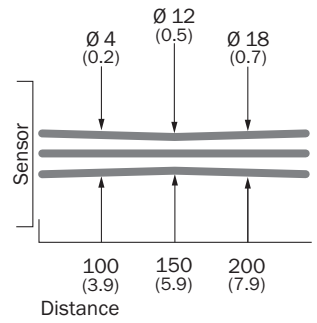

Sensing distance 150 mm





All dimensions in mm (inch)

## Recommended accessories

Other models and accessories → [www.sick.com/LUT1](http://www.sick.com/LUT1)

	Brief description	Type	part no.
Commissioning aids and test equipment			
	<ul style="list-style-type: none"> <li><b>Description:</b> Writing chalk, red fluorescence</li> </ul>	LUM-KLK	1002959
	<ul style="list-style-type: none"> <li><b>Description:</b> Thick chalk, red fluorescent, 12 units</li> </ul>	LUM-FT	1004460

	Brief description	Type	part no.
connectors and cables			
	<ul style="list-style-type: none"> <li><b>Description:</b> Unshielded</li> <li><b>Connection type head A:</b> Female connector, M12, 5-pin, straight, A-coded</li> <li><b>Connection systems:</b> Screw-type terminals</li> <li><b>Permitted cross-section:</b> ≤ 0.75 mm<sup>2</sup></li> </ul>	DOS-1205-G	6009719
	<ul style="list-style-type: none"> <li><b>Description:</b> Unshielded</li> <li><b>Connection type head A:</b> Female connector, M12, 5-pin, angled, A-coded</li> <li><b>Connection systems:</b> Screw-type terminals</li> <li><b>Permitted cross-section:</b> ≤ 0.75 mm<sup>2</sup></li> </ul>	DOS-1205-W	6009720
	<ul style="list-style-type: none"> <li><b>Description:</b> Sensor/actuator cable, unshielded</li> <li><b>Connection type head A:</b> Female connector, M12, 5-pin, angled, A-coded</li> <li><b>Connection type head B:</b> Flying leads</li> <li><b>Signal type:</b> Sensor/actuator cable</li> <li><b>Cable:</b> 2 m, 5-wire, PVC</li> <li><b>Application:</b> Untaminated zones, Zones with chemicals</li> </ul>	YG2A15-020VB5XLEAX	2096215
	<ul style="list-style-type: none"> <li><b>Description:</b> Sensor/actuator cable, unshielded</li> <li><b>Connection type head A:</b> Female connector, M12, 5-pin, angled, A-coded</li> <li><b>Connection type head B:</b> Flying leads</li> <li><b>Signal type:</b> Sensor/actuator cable</li> <li><b>Cable:</b> 5 m, 5-wire, PVC</li> <li><b>Application:</b> Untaminated zones, Zones with chemicals</li> </ul>	YG2A15-050VB5XLEAX	2096216
	<ul style="list-style-type: none"> <li><b>Description:</b> Sensor/actuator cable, unshielded</li> <li><b>Connection type head A:</b> Female connector, M12, 5-pin, angled, A-coded</li> <li><b>Connection type head B:</b> Flying leads</li> <li><b>Signal type:</b> Sensor/actuator cable</li> <li><b>Cable:</b> 10 m, 5-wire, PVC</li> <li><b>Application:</b> Untaminated zones, Zones with chemicals</li> </ul>	YG2A15-100VB5XLEAX	2096217
	<ul style="list-style-type: none"> <li><b>Description:</b> Sensor/actuator cable, unshielded</li> <li><b>Connection type head A:</b> Female connector, M12, 5-pin, straight, A-coded</li> <li><b>Connection type head B:</b> Flying leads</li> <li><b>Signal type:</b> Sensor/actuator cable</li> <li><b>Cable:</b> 2 m, 5-wire, PVC</li> <li><b>Application:</b> Untaminated zones, Zones with chemicals</li> </ul>	YF2A15-020VB5XLEAX	2096239
	<ul style="list-style-type: none"> <li><b>Description:</b> Sensor/actuator cable, unshielded</li> <li><b>Connection type head A:</b> Female connector, M12, 5-pin, straight, A-coded</li> <li><b>Connection type head B:</b> Flying leads</li> <li><b>Signal type:</b> Sensor/actuator cable</li> <li><b>Cable:</b> 5 m, 5-wire, PVC</li> <li><b>Application:</b> Untaminated zones, Zones with chemicals</li> </ul>	YF2A15-050VB5XLEAX	2096240
	<ul style="list-style-type: none"> <li><b>Description:</b> Sensor/actuator cable, unshielded</li> <li><b>Connection type head A:</b> Female connector, M12, 5-pin, straight, A-coded</li> <li><b>Connection type head B:</b> Flying leads</li> <li><b>Signal type:</b> Sensor/actuator cable</li> <li><b>Cable:</b> 10 m, 5-wire, PVC</li> <li><b>Application:</b> Untaminated zones, Zones with chemicals</li> </ul>	YF2A15-100VB5XLEAX	2096241
	<ul style="list-style-type: none"> <li><b>Description:</b> Sensor/actuator cable, unshielded</li> <li><b>Connection type head A:</b> Female connector, M12, 5-pin, angled, A-coded</li> <li><b>Connection type head B:</b> Flying leads</li> <li><b>Signal type:</b> Sensor/actuator cable</li> <li><b>Cable:</b> 0.6 m, 5-wire, PVC</li> <li><b>Application:</b> Untaminated zones, Zones with chemicals</li> </ul>	YG2A15-C60VB5XLEAX	2145573
	<ul style="list-style-type: none"> <li><b>Description:</b> Sensor/actuator cable, unshielded</li> <li><b>Connection type head A:</b> Female connector, M12, 5-pin, angled, A-coded</li> <li><b>Connection type head B:</b> Flying leads</li> <li><b>Signal type:</b> Sensor/actuator cable</li> <li><b>Cable:</b> 1 m, 5-wire, PVC</li> <li><b>Application:</b> Untaminated zones, Zones with chemicals</li> </ul>	YG2A15-010VB5XLEAX	2145574
	<ul style="list-style-type: none"> <li><b>Description:</b> Sensor/actuator cable, unshielded</li> <li><b>Connection type head A:</b> Female connector, M12, 5-pin, angled, A-coded</li> <li><b>Connection type head B:</b> Flying leads</li> <li><b>Signal type:</b> Sensor/actuator cable</li> <li><b>Cable:</b> 3 m, 5-wire, PVC</li> </ul>	YG2A15-030VB5XLEAX	2145575

	Brief description	Type	part no.
	<ul style="list-style-type: none"> <li>• <b>Application:</b> Uncontaminated zones, Zones with chemicals</li> <li>• <b>Description:</b> Sensor/actuator cable, unshielded</li> <li>• <b>Connection type head A:</b> Female connector, M12, 5-pin, straight, A-coded</li> <li>• <b>Connection type head B:</b> Flying leads</li> <li>• <b>Signal type:</b> Sensor/actuator cable</li> <li>• <b>Cable:</b> 0.6 m, 5-wire, PVC</li> <li>• <b>Application:</b> Uncontaminated zones, Zones with chemicals</li> </ul>	YF2A15-C60VB5XLEAX	2145570
	<ul style="list-style-type: none"> <li>• <b>Description:</b> Sensor/actuator cable, unshielded</li> <li>• <b>Connection type head A:</b> Female connector, M12, 5-pin, straight, A-coded</li> <li>• <b>Connection type head B:</b> Flying leads</li> <li>• <b>Signal type:</b> Sensor/actuator cable</li> <li>• <b>Cable:</b> 3 m, 5-wire, PVC</li> <li>• <b>Application:</b> Uncontaminated zones, Zones with chemicals</li> </ul>	YF2A15-030VB5XLEAX	2145572

## SICK AT A GLANCE

SICK is one of the leading manufacturers of intelligent sensors and sensor solutions for industrial applications. A unique range of products and services creates the perfect basis for controlling processes securely and efficiently, protecting individuals from accidents and preventing damage to the environment.

We have extensive experience in a wide range of industries and understand their processes and requirements. With intelligent sensors, we can deliver exactly what our customers need. In application centers in Europe, Asia and North America, system solutions are tested and optimized in accordance with customer specifications. All this makes us a reliable supplier and development partner.

Comprehensive services complete our offering: SICK LifeTime Services provide support throughout the machine life cycle and ensure safety and productivity.

For us, that is “Sensor Intelligence.”

## WORLDWIDE PRESENCE:

Contacts and other locations –[www.sick.com](http://www.sick.com)