



DME5000-221

DME5000

TIME-OF-FLIGHT SENSORS

SICK
Sensor Intelligence.



Ordering information

Type	part no.
DME5000-221	1024085

Other models and accessories → www.sick.com/DME5000



Detailed technical data

Features

Measuring range	0.15 m ... 150 m, on "diamond grade" reflective tape ¹⁾
Target	Reflector
Resolution	50 µm ... 5,000 µm
Repeatability	1 mm ^{1) 2)}
Measurement accuracy	± 3 mm
Response time	6 ms
Output time	1 ms
Emitted beam	
Light source	Laser, red ³⁾
Type of light	Visible red light
Typ. light spot size (distance)	130 mm (at 70 m) 270 mm (at 150 m) 360 mm (at 220 m)
Key laser figures	
Normative reference	IEC 60825-1:2014, EN 60825-1:2014
Laser class	2 ⁴⁾
Max. movement speed	10 m/s
Safety-related parameters	
MTTF _D	101 years
DC _{avg}	0%

¹⁾ On "diamond grade" reflective tape.

²⁾ Statistical error 1 σ, environmental conditions constant, min. warm-up time 10 min.

³⁾ Average service life of 50,000 h at T_A = +25 °C.

⁴⁾ Do not intentionally look into the laser beam. Never point the laser beam at people's eyes.

Interfaces

SSI	✓
Digital output	Number
	Type
	Maximum output current I_A
Multifunctional input (MF)	1 x MF ^{3) 4)}

¹⁾ Max. 100 nF/20 mA.

²⁾ HIGH = $> V_S - 3 V$ / LOW = $< 2 V$.

³⁾ HIGH = $> 12 V$ / LOW = $< 3 V$.

⁴⁾ Not reverse-polarity protected.

Electronics

Supply voltage U_B	DC 18 V ... 30 V, limit values
Current consumption	At 24 V DC $< 1,000$ mA
Ripple	$< 5 V_{pp}$ ¹⁾
Initialization time	1.5 s ²⁾
Display	Display
Enclosure rating	IP65
Protection class	II ³⁾
Connection type	Male connector

¹⁾ May not fall short of or exceed V_S tolerances.

²⁾ After loss of reflector < 1 s at max. speed $V_{max} < 1$ m/s.

³⁾ Reference voltage DC 32 V.

Mechanics

Dimensions (W x H x D)	61 mm x 101 mm x 176 mm
Housing material	Metal (zinc diecast)
Window material	Glass
Weight	Approx. 1,650 g

Ambient data

Ambient temperature, operation	-40 °C ... +55 °C, operation with heating -40 °C ... +75 °C, operation with cooling case
Ambient temperature, storage	-25 °C ... +75 °C
Effect of air pressure	0.3 ppm/hPa
Effect of air temperature	1 ppm/K
Temperature drift	Typ. 0.1 mm/K
Typ. Ambient light immunity	$\leq 40,000$ lx
Mechanical load	Shock: (EN 600 68-2-27 / -2-29) Sine: (EN 600 68-2-6) Noise: (EN 600 68-2-64)
Electromagnetic compatibility (EMC)	EN 61000-6-2, EN 55011

Certificates

EU declaration of conformity	✓
UK declaration of conformity	✓
ACMA declaration of conformity	✓
Moroccan declaration of conformity	✓
China RoHS	✓

Classifications

ECLASS 5.0	27270801
ECLASS 5.1.4	27270801
ECLASS 6.0	27270801
ECLASS 6.2	27270801
ECLASS 7.0	27270801
ECLASS 8.0	27270801
ECLASS 8.1	27270801
ECLASS 9.0	27270801
ECLASS 10.0	27270801
ECLASS 11.0	27270801
ECLASS 12.0	27270916
ETIM 5.0	EC001825
ETIM 6.0	EC001825
ETIM 7.0	EC001825
ETIM 8.0	EC001825
UNSPSC 16.0901	41111613

Dimensional drawing DME5000 SSI

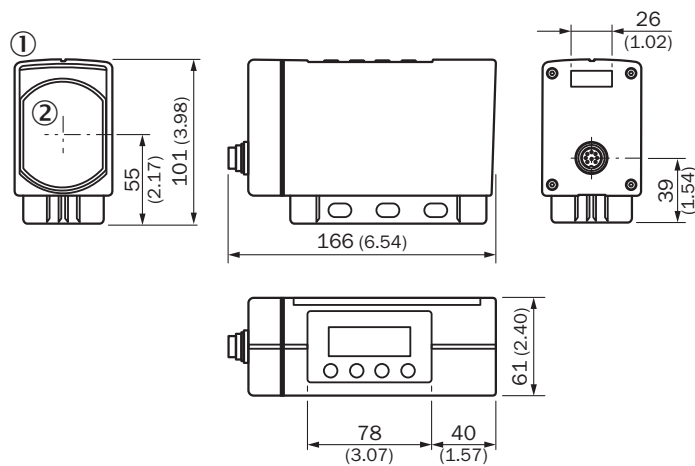

Dimensions in mm (inch)

① LC display

② Center of optical axis

Connection type DME4/5xxx SSI/RS-422 Connector M16, 8-pin



Connection diagram

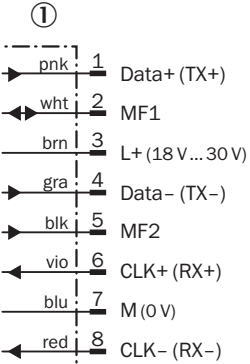

① Connector M16, 8-pin

Adjustment possible

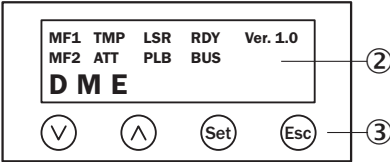

② LC display
 ③ Keypad

Working range diagram DL1000 measuring range based on measurement cycle time and reflector type







Recommended accessories

Other models and accessories → www.sick.com/DME5000

	Brief description	Type	part no.
Mounting systems			
	<ul style="list-style-type: none"> Description: Alignment unit for DME5000, stainless steel (1.4541), incl. mounting material, additional base plate mounting kit required Items supplied: Mounting hardware included 	BEF-AH-DME	2027721
reflectors and optics			
	<ul style="list-style-type: none"> Description: Reflector plate, "diamond grade" reflective tape, 665 mm x 665 mm, base plate material: aluminum, screw connection Ambient operating temperature: -25 °C ... +65 °C 	PL560DG	1016806

	Brief description	Type	part no.
connectors and cables			
	<ul style="list-style-type: none"> Connection type head A: Female connector, M12, 5-pin, A-coded Connection type head B: Flying leads Signal type: Power, CAN Cable: 5 m, 5-wire Description: Power, unshielded, CAN 	DOL-1205-G05M_Can	6021166
	<ul style="list-style-type: none"> Connection type head A: Female connector, M12, 5-pin, straight, A-coded Connection type head B: Flying leads Signal type: Fieldbus, CANopen, DeviceNet™ Cable: 10 m, 5-wire, PUR, halogen-free Description: Fieldbus, shielded, CANopen, DeviceNet™ Connection systems: Flying leads Note: Shielded on pin 1 	YF2A14-100C1BXLEAX	6021175
	<ul style="list-style-type: none"> Description: Shielded Connection type head A: Female connector, M12, 8-pin, straight Connection type head B: Flying leads Cable: 2 m, 8-wire, PUR, halogen-free Connection systems: Flying leads Application: Zones with oils and lubricants 	YF2A68-020XXXXLEAX	6032448
	<ul style="list-style-type: none"> Description: Shielded Connection type head A: Female connector, M12, 8-pin, straight Connection type head B: Flying leads Cable: 5 m, 8-wire, PUR, halogen-free Application: Drag chain operation, Zones with oils and lubricants 	YF2A68-050XXXXLEAX	6032449
	<ul style="list-style-type: none"> Description: Shielded Connection type head A: Female connector, M12, 8-pin, straight Connection type head B: Flying leads Cable: 10 m, 8-wire, PUR, halogen-free Application: Drag chain operation, Zones with oils and lubricants 	YF2A68-100XXXXLEAX	6032450
	<ul style="list-style-type: none"> Connection type head A: Female connector, M12, 5-pin, straight, B-coded Connection type head B: Flying leads Signal type: PROFIBUS DP Cable: 10 m, 2-wire, PUR, halogen-free Description: PROFIBUS DP, twisted pair, shielded Connection systems: Flying leads Application: Zones with oils and lubricants 	DOL-1205-G10MQ	6026008
	<ul style="list-style-type: none"> Connection type head A: Female connector, M12, 5-pin, straight, B-coded Connection type head B: Flying leads Signal type: PROFIBUS DP Cable: 5 m, 2-wire, PUR, halogen-free Description: PROFIBUS DP, twisted pair, shielded Connection systems: Flying leads Application: Zones with oils and lubricants 	DOL-1205-G05MQ	6026006
	<ul style="list-style-type: none"> Connection type head A: Male connector, M12, 4-pin, straight, B-coded Signal type: PROFIBUS DP Description: PROFIBUS DP, terminal resistor 	STE-END-Q	6021156
	<ul style="list-style-type: none"> Connection type head A: Female connector, M12, 5-pin, straight, B-coded Connection type head B: Flying leads Signal type: PROFIBUS DP Cable: 15 m, 2-wire, PUR, halogen-free Description: PROFIBUS DP, twisted pair, shielded Connection systems: Flying leads Application: Zones with oils and lubricants 	DOL-1205-G15MQ	6032637
	<ul style="list-style-type: none"> Connection type head A: Male connector, M12, 5-pin, straight, B-coded Connection type head B: Flying leads Signal type: PROFIBUS DP Cable: 5 m, 2-wire, PUR, halogen-free Description: PROFIBUS DP, twisted pair, shielded Note: Wire shield Al-Pt film, overall shield C-screen tin-plated Application: Zones with oils and lubricants, Drag chain operation 	STL-1205-G05MQ	6026005
	<ul style="list-style-type: none"> Connection type head A: Male connector, M12, 5-pin, straight, B-coded Connection type head B: Flying leads Signal type: PROFIBUS DP Cable: 10 m, 2-wire, PUR, halogen-free Description: PROFIBUS DP, twisted pair, shielded Note: Wire shield Al-Pt film, overall shield C-screen tin-plated 	STL-1205-G10MQ	6026007

	Brief description	Type	part no.
	<ul style="list-style-type: none"> • Application: Zones with oils and lubricants, Drag chain operation • Connection type head A: Male connector, M12, 5-pin, straight, B-coded • Connection type head B: Flying leads • Signal type: PROFIBUS DP • Cable: 15 m, 2-wire, PUR, halogen-free • Description: PROFIBUS DP, twisted pair, shielded • Application: Zones with oils and lubricants, Drag chain operation 	STL-1205-G15MQ	6036898
	<ul style="list-style-type: none"> • Connection type head A: Female connector, M12, 5-pin, straight • Connection type head B: Flying leads • Signal type: CANopen • Cable: 6 m • Description: CANopen, shielded 	DOL-1205-G06MK	6028326
	<ul style="list-style-type: none"> • Connection type head A: Female connector, 7/8", 5-pin, straight • Signal type: DeviceNet™, CANopen • Description: DeviceNet™, terminal resistor, shielded, CANopen • Permitted cross-section: ≤ 1.5 mm² • Note: For field bus technology 	DOS-7805-GKEND	6028329
	<ul style="list-style-type: none"> • Connection type head A: Female connector, M16, 8-pin, straight • Connection type head B: Flying leads • Cable: 5 m, PUR, halogen-free • Description: Shielded 	YF2Z18-050XXXLE-BX	2026742
	<ul style="list-style-type: none"> • Connection type head A: Female connector, M16, 8-pin, straight • Connection type head B: Flying leads • Cable: 10 m, PUR, halogen-free • Description: Shielded 	YF2Z18-100XXXLE-BX	2027193

SICK AT A GLANCE

SICK is one of the leading manufacturers of intelligent sensors and sensor solutions for industrial applications. A unique range of products and services creates the perfect basis for controlling processes securely and efficiently, protecting individuals from accidents and preventing damage to the environment.

We have extensive experience in a wide range of industries and understand their processes and requirements. With intelligent sensors, we can deliver exactly what our customers need. In application centers in Europe, Asia and North America, system solutions are tested and optimized in accordance with customer specifications. All this makes us a reliable supplier and development partner.

Comprehensive services complete our offering: SICK LifeTime Services provide support throughout the machine life cycle and ensure safety and productivity.

For us, that is “Sensor Intelligence.”

WORLDWIDE PRESENCE:

Contacts and other locations –www.sick.com