





### Ordering information

Type	part no.
DME5000-121	1024083

Other models and accessories → [www.sick.com/DME5000](http://www.sick.com/DME5000)



### Detailed technical data

#### Features

<b>Measuring range</b>	0.15 m ... 70 m, on "diamond grade" reflective tape <sup>1)</sup>
<b>Target</b>	Reflector
<b>Resolution</b>	50 µm ... 5,000 µm
<b>Repeatability</b>	0.5 mm <sup>1) 2)</sup>
<b>Measurement accuracy</b>	± 2 mm
<b>Response time</b>	6 ms
<b>Output time</b>	1 ms
<b>Emitted beam</b>	
Light source	Laser, red <sup>3)</sup>
Type of light	Visible red light
Typ. light spot size (distance)	130 mm (at 70 m) 270 mm (at 150 m) 360 mm (at 220 m)
<b>Key laser figures</b>	
Normative reference	IEC 60825-1:2014, EN 60825-1:2014
Laser class	2 <sup>4)</sup>
<b>Max. movement speed</b>	10 m/s
<b>Safety-related parameters</b>	
MTTF <sub>D</sub>	101 years
DC <sub>avg</sub>	0%

<sup>1)</sup> On "diamond grade" reflective tape.

<sup>2)</sup> Statistical error 1 σ, environmental conditions constant, min. warm-up time 10 min.

<sup>3)</sup> Average service life of 50,000 h at T<sub>A</sub> = +25 °C.

<sup>4)</sup> Do not intentionally look into the laser beam. Never point the laser beam at people's eyes.

## Interfaces

<b>SSI</b>	✓
<b>Digital output</b>	Number
	Type
	Maximum output current $I_A$
<b>Multifunctional input (MF)</b>	1 x MF <sup>3) 4)</sup>

<sup>1)</sup> Max. 100 nF/20 mA.

<sup>2)</sup> HIGH =  $> V_S - 3 \text{ V}$  / LOW =  $< 2 \text{ V}$ .

<sup>3)</sup> HIGH =  $> 12 \text{ V}$  / LOW =  $< 3 \text{ V}$ .

<sup>4)</sup> Not reverse-polarity protected.

## Electronics

<b>Supply voltage <math>U_B</math></b>	DC 18 V ... 30 V, limit values
<b>Current consumption</b>	At 24 V DC $< 1,000 \text{ mA}$
<b>Ripple</b>	$< 5 \text{ V}_{pp}$ <sup>1)</sup>
<b>Initialization time</b>	$1.5 \text{ s}$ <sup>2)</sup>
<b>Display</b>	Display
<b>Enclosure rating</b>	IP65
<b>Protection class</b>	II <sup>3)</sup>
<b>Connection type</b>	Male connector

<sup>1)</sup> May not fall short of or exceed  $V_S$  tolerances.

<sup>2)</sup> After loss of reflector  $< 1 \text{ s}$  at max. speed  $V_{max} < 1 \text{ m/s}$ .

<sup>3)</sup> Reference voltage DC 32 V.

## Mechanics

<b>Dimensions (W x H x D)</b>	61 mm x 101 mm x 176 mm
<b>Housing material</b>	Metal (zinc diecast)
<b>Window material</b>	Glass
<b>Weight</b>	Approx. 1,650 g

## Ambient data

<b>Ambient temperature, operation</b>	-40 °C ... +55 °C, operation with heating -40 °C ... +75 °C, operation with cooling case
<b>Ambient temperature, storage</b>	-25 °C ... +75 °C
<b>Effect of air pressure</b>	0.3 ppm/hPa
<b>Effect of air temperature</b>	1 ppm/K
<b>Temperature drift</b>	Typ. 0.1 mm/K
<b>Typ. Ambient light immunity</b>	$\leq 40,000 \text{ lx}$
<b>Mechanical load</b>	Shock: (EN 600 68-2-27 / -2-29) Sine: (EN 600 68-2-6) Noise: (EN 600 68-2-64)
<b>Electromagnetic compatibility (EMC)</b>	EN 61000-6-2, EN 55011

### Certificates

<b>EU declaration of conformity</b>	✓
<b>UK declaration of conformity</b>	✓
<b>ACMA declaration of conformity</b>	✓
<b>Moroccan declaration of conformity</b>	✓
<b>China RoHS</b>	✓

### Classifications

<b>ECLASS 5.0</b>	27270801
<b>ECLASS 5.1.4</b>	27270801
<b>ECLASS 6.0</b>	27270801
<b>ECLASS 6.2</b>	27270801
<b>ECLASS 7.0</b>	27270801
<b>ECLASS 8.0</b>	27270801
<b>ECLASS 8.1</b>	27270801
<b>ECLASS 9.0</b>	27270801
<b>ECLASS 10.0</b>	27270801
<b>ECLASS 11.0</b>	27270801
<b>ECLASS 12.0</b>	27270916
<b>ETIM 5.0</b>	EC001825
<b>ETIM 6.0</b>	EC001825
<b>ETIM 7.0</b>	EC001825
<b>ETIM 8.0</b>	EC001825
<b>UNSPSC 16.0901</b>	41111613

### Dimensional drawing DME5000 SSI

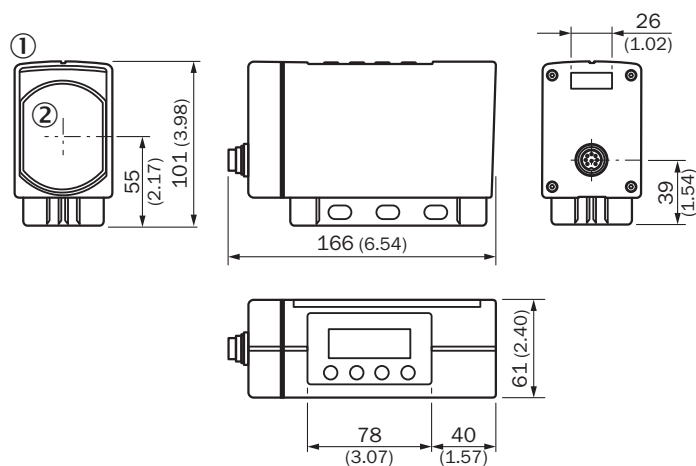

Dimensions in mm (inch)

① LC display

② Center of optical axis

Connection type DME4/5xxx SSI/RS-422 Connector M16, 8-pin



Connection diagram

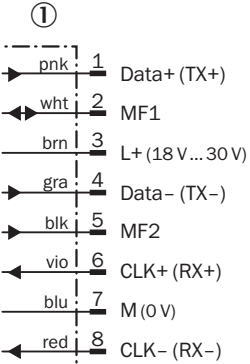

① Connector M16, 8-pin

Adjustment possible

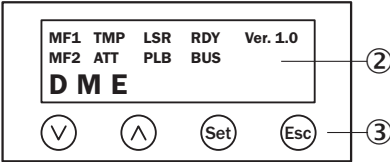

② LC display  
③ Keypad

### Working range diagram DL1000 measuring range based on measurement cycle time and reflector type







### Recommended accessories

Other models and accessories → [www.sick.com/DME5000](http://www.sick.com/DME5000)

	Brief description	Type	part no.
<b>Mounting systems</b>			
	<ul style="list-style-type: none"> <li><b>Description:</b> Alignment unit for DME5000, stainless steel (1.4541), incl. mounting material, additional base plate mounting kit required</li> <li><b>Items supplied:</b> Mounting hardware included</li> </ul>	BEF-AH-DME	2027721
<b>reflectors and optics</b>			
	<ul style="list-style-type: none"> <li><b>Description:</b> Reflector plate, "diamond grade" reflective tape, 665 mm x 665 mm, base plate material: aluminum, screw connection</li> <li><b>Ambient operating temperature:</b> -25 °C ... +65 °C</li> </ul>	PL560DG	1016806

	Brief description	Type	part no.
	<ul style="list-style-type: none"> <li><b>Connection type head A:</b> Female connector, M12, 5-pin, A-coded</li> <li><b>Connection type head B:</b> Flying leads</li> <li><b>Signal type:</b> Power, CAN</li> <li><b>Cable:</b> 5 m, 5-wire</li> <li><b>Description:</b> Power, unshielded, CAN</li> </ul>	DOL-1205-G05M_Can	6021166
	<ul style="list-style-type: none"> <li><b>Connection type head A:</b> Female connector, M12, 5-pin, straight, A-coded</li> <li><b>Connection type head B:</b> Flying leads</li> <li><b>Signal type:</b> Fieldbus, CANopen, DeviceNet™</li> <li><b>Cable:</b> 10 m, 5-wire, PUR, halogen-free</li> <li><b>Description:</b> Fieldbus, shielded, CANopen, DeviceNet™</li> <li><b>Connection systems:</b> Flying leads</li> <li><b>Note:</b> Shielded on pin 1</li> </ul>	YF2A14-100C1BXLEAX	6021175
	<ul style="list-style-type: none"> <li><b>Description:</b> Shielded</li> <li><b>Connection type head A:</b> Female connector, M12, 8-pin, straight</li> <li><b>Connection type head B:</b> Flying leads</li> <li><b>Cable:</b> 2 m, 8-wire, PUR, halogen-free</li> <li><b>Connection systems:</b> Flying leads</li> <li><b>Application:</b> Zones with oils and lubricants</li> </ul>	YF2A68-020XXXXLEAX	6032448
	<ul style="list-style-type: none"> <li><b>Description:</b> Shielded</li> <li><b>Connection type head A:</b> Female connector, M12, 8-pin, straight</li> <li><b>Connection type head B:</b> Flying leads</li> <li><b>Cable:</b> 5 m, 8-wire, PUR, halogen-free</li> <li><b>Application:</b> Drag chain operation, Zones with oils and lubricants</li> </ul>	YF2A68-050XXXXLEAX	6032449
	<ul style="list-style-type: none"> <li><b>Description:</b> Shielded</li> <li><b>Connection type head A:</b> Female connector, M12, 8-pin, straight</li> <li><b>Connection type head B:</b> Flying leads</li> <li><b>Cable:</b> 10 m, 8-wire, PUR, halogen-free</li> <li><b>Application:</b> Drag chain operation, Zones with oils and lubricants</li> </ul>	YF2A68-100XXXXLEAX	6032450
	<ul style="list-style-type: none"> <li><b>Connection type head A:</b> Female connector, M12, 5-pin, straight, B-coded</li> <li><b>Connection type head B:</b> Flying leads</li> <li><b>Signal type:</b> PROFIBUS DP</li> <li><b>Cable:</b> 10 m, 2-wire, PUR, halogen-free</li> <li><b>Description:</b> PROFIBUS DP, twisted pair, shielded</li> <li><b>Connection systems:</b> Flying leads</li> <li><b>Application:</b> Zones with oils and lubricants</li> </ul>	DOL-1205-G10MQ	6026008
	<ul style="list-style-type: none"> <li><b>Connection type head A:</b> Female connector, M12, 5-pin, straight, B-coded</li> <li><b>Connection type head B:</b> Flying leads</li> <li><b>Signal type:</b> PROFIBUS DP</li> <li><b>Cable:</b> 5 m, 2-wire, PUR, halogen-free</li> <li><b>Description:</b> PROFIBUS DP, twisted pair, shielded</li> <li><b>Connection systems:</b> Flying leads</li> <li><b>Application:</b> Zones with oils and lubricants</li> </ul>	DOL-1205-G05MQ	6026006
	<ul style="list-style-type: none"> <li><b>Connection type head A:</b> Male connector, M12, 4-pin, straight, B-coded</li> <li><b>Signal type:</b> PROFIBUS DP</li> <li><b>Description:</b> PROFIBUS DP, terminal resistor</li> </ul>	STE-END-Q	6021156
	<ul style="list-style-type: none"> <li><b>Connection type head A:</b> Female connector, M12, 5-pin, straight, B-coded</li> <li><b>Connection type head B:</b> Flying leads</li> <li><b>Signal type:</b> PROFIBUS DP</li> <li><b>Cable:</b> 15 m, 2-wire, PUR, halogen-free</li> <li><b>Description:</b> PROFIBUS DP, twisted pair, shielded</li> <li><b>Connection systems:</b> Flying leads</li> <li><b>Application:</b> Zones with oils and lubricants</li> </ul>	DOL-1205-G15MQ	6032637
	<ul style="list-style-type: none"> <li><b>Connection type head A:</b> Male connector, M12, 5-pin, straight, B-coded</li> <li><b>Connection type head B:</b> Flying leads</li> <li><b>Signal type:</b> PROFIBUS DP</li> <li><b>Cable:</b> 5 m, 2-wire, PUR, halogen-free</li> <li><b>Description:</b> PROFIBUS DP, twisted pair, shielded</li> <li><b>Note:</b> Wire shield Al-Pt film, overall shield C-screen tin-plated</li> <li><b>Application:</b> Zones with oils and lubricants, Drag chain operation</li> </ul>	STL-1205-G05MQ	6026005
	<ul style="list-style-type: none"> <li><b>Connection type head A:</b> Male connector, M12, 5-pin, straight, B-coded</li> <li><b>Connection type head B:</b> Flying leads</li> <li><b>Signal type:</b> PROFIBUS DP</li> <li><b>Cable:</b> 10 m, 2-wire, PUR, halogen-free</li> <li><b>Description:</b> PROFIBUS DP, twisted pair, shielded</li> <li><b>Note:</b> Wire shield Al-Pt film, overall shield C-screen tin-plated</li> </ul>	STL-1205-G10MQ	6026007

	Brief description	Type	part no.
	<ul style="list-style-type: none"> <li>• <b>Application:</b> Zones with oils and lubricants, Drag chain operation</li> <li>• <b>Connection type head A:</b> Male connector, M12, 5-pin, straight, B-coded</li> <li>• <b>Connection type head B:</b> Flying leads</li> <li>• <b>Signal type:</b> PROFIBUS DP</li> <li>• <b>Cable:</b> 15 m, 2-wire, PUR, halogen-free</li> <li>• <b>Description:</b> PROFIBUS DP, twisted pair, shielded</li> <li>• <b>Application:</b> Zones with oils and lubricants, Drag chain operation</li> </ul>	STL-1205-G15MQ	6036898
	<ul style="list-style-type: none"> <li>• <b>Connection type head A:</b> Female connector, M12, 5-pin, straight</li> <li>• <b>Connection type head B:</b> Flying leads</li> <li>• <b>Signal type:</b> CANopen</li> <li>• <b>Cable:</b> 6 m</li> <li>• <b>Description:</b> CANopen, shielded</li> </ul>	DOL-1205-G06MK	6028326
	<ul style="list-style-type: none"> <li>• <b>Connection type head A:</b> Female connector, 7/8", 5-pin, straight</li> <li>• <b>Signal type:</b> DeviceNet™, CANopen</li> <li>• <b>Description:</b> DeviceNet™, terminal resistor, shielded, CANopen</li> <li>• <b>Permitted cross-section:</b> ≤ 1.5 mm<sup>2</sup></li> <li>• <b>Note:</b> For field bus technology</li> </ul>	DOS-7805-GKEND	6028329
	<ul style="list-style-type: none"> <li>• <b>Connection type head A:</b> Female connector, M16, 8-pin, straight</li> <li>• <b>Connection type head B:</b> Flying leads</li> <li>• <b>Cable:</b> 5 m, PUR, halogen-free</li> <li>• <b>Description:</b> Shielded</li> </ul>	YF2Z18-050XXXLE-BX	2026742
	<ul style="list-style-type: none"> <li>• <b>Connection type head A:</b> Female connector, M16, 8-pin, straight</li> <li>• <b>Connection type head B:</b> Flying leads</li> <li>• <b>Cable:</b> 10 m, PUR, halogen-free</li> <li>• <b>Description:</b> Shielded</li> </ul>	YF2Z18-100XXXLE-BX	2027193

## SICK AT A GLANCE

SICK is one of the leading manufacturers of intelligent sensors and sensor solutions for industrial applications. A unique range of products and services creates the perfect basis for controlling processes securely and efficiently, protecting individuals from accidents and preventing damage to the environment.

We have extensive experience in a wide range of industries and understand their processes and requirements. With intelligent sensors, we can deliver exactly what our customers need. In application centers in Europe, Asia and North America, system solutions are tested and optimized in accordance with customer specifications. All this makes us a reliable supplier and development partner.

Comprehensive services complete our offering: SICK LifeTime Services provide support throughout the machine life cycle and ensure safety and productivity.

For us, that is “Sensor Intelligence.”

## WORLDWIDE PRESENCE:

Contacts and other locations –[www.sick.com](http://www.sick.com)