



# LUT3-950

LUT3

LUMINESCENCE SENSORS

**SICK**  
Sensor Intelligence.



Illustration may differ



### Ordering information

Type	part no.
LUT3-950	1019287

Other models and accessories → [www.sick.com/LUT3](http://www.sick.com/LUT3)

### Detailed technical data

#### Features

<b>Housing design</b>	Large
<b>Dimensions (W x H x D)</b>	30.4 mm x 53 mm x 80 mm
<b>Light source</b>	LED, Ultraviolet light <sup>1)</sup>
<b>Light spot size</b>	5 mm x 15 mm
<b>Receiving filters</b>	≤ 420 nm <sup>2)</sup>
<b>Wave length</b>	375 nm
<b>Sensing distance</b>	≤ 50 mm <sup>3)</sup>
<b>Receiving range</b>	450 nm ... 750 nm
<b>Adjustment</b>	Potentiometer
<b>Output function</b>	Light switching

<sup>1)</sup> Average service life: 100,000 h at T<sub>J</sub> = +25 °C.

<sup>2)</sup> Filter blocks shorter wavelengths to suppress background luminescence.

<sup>3)</sup> From leading edge of lens.

#### Electronics

<b>Supply voltage</b>	12 V DC ... 30 V DC <sup>1)</sup>
<b>Ripple</b>	< 2 V <sub>pp</sub> <sup>2)</sup>
<b>Current consumption</b>	< 60 mA <sup>3)</sup>
<b>Switching frequency</b>	1.5 kHz <sup>4)</sup>

<sup>1)</sup> Limit values when operated in short-circuit protected network: max. 8 A.

<sup>2)</sup> May not fall below or exceed U<sub>V</sub> tolerances.

<sup>3)</sup> Without load.

<sup>4)</sup> With light/dark ratio 1:1.

<sup>5)</sup> Reference voltage DC 50 V.

<b>Response time</b>	350 µs
<b>Switching output</b>	PNP NPN
<b>Switching output (voltage)</b>	PNP: HIGH = $V_S - \leq 3 \text{ V}$ / LOW = approx. 0 V NPN: HIGH = approx. $U_V$ / LOW $\leq 2 \text{ V}$
<b>Switching mode</b>	Light switching
<b>Analog output</b>	0.5 mA ... 10 mA
<b>Output current <math>I_{\text{max}}</math></b>	100 mA
<b>Protection class</b>	II <sup>5)</sup>
<b>Circuit protection</b>	$U_V$ connections, reverse polarity protected Output Q short-circuit protected Interference pulse suppression
<b>Connection type</b>	Plug, M12, 5-pin

<sup>1)</sup> Limit values when operated in short-circuit protected network: max. 8 A.

<sup>2)</sup> May not fall below or exceed  $U_V$  tolerances.

<sup>3)</sup> Without load.

<sup>4)</sup> With light/dark ratio 1:1.

<sup>5)</sup> Reference voltage DC 50 V.

## Mechanics

<b>Housing material</b>	Zinc diecast
<b>Weight</b>	400 g

## Ambient data

<b>Ambient operating temperature</b>	-10 °C ... +55 °C
<b>Ambient temperature, storage</b>	-25 °C ... +75 °C
<b>Shock load</b>	According to IEC 60068
<b>Enclosure rating</b>	IP67

## Certificates

<b>EU declaration of conformity</b>	✓
<b>UK declaration of conformity</b>	✓
<b>ACMA declaration of conformity</b>	✓
<b>Moroccan declaration of conformity</b>	✓
<b>China RoHS</b>	✓
<b>cULus certificate</b>	✓
<b>Photobiological safety (IEC EN 62471)</b>	✓

## Classifications

<b>ECLASS 5.0</b>	27270908
<b>ECLASS 5.1.4</b>	27270908
<b>ECLASS 6.0</b>	27270908
<b>ECLASS 6.2</b>	27270908
<b>ECLASS 7.0</b>	27270908

<b>ECLASS 8.0</b>	27270908
<b>ECLASS 8.1</b>	27270908
<b>ECLASS 9.0</b>	27270908
<b>ECLASS 10.0</b>	27270908
<b>ECLASS 11.0</b>	27270908
<b>ECLASS 12.0</b>	27270908
<b>ETIM 5.0</b>	EC001822
<b>ETIM 6.0</b>	EC001822
<b>ETIM 7.0</b>	EC001822
<b>ETIM 8.0</b>	EC001822
<b>UNSPSC 16.0901</b>	39121528

### Dimensional drawing

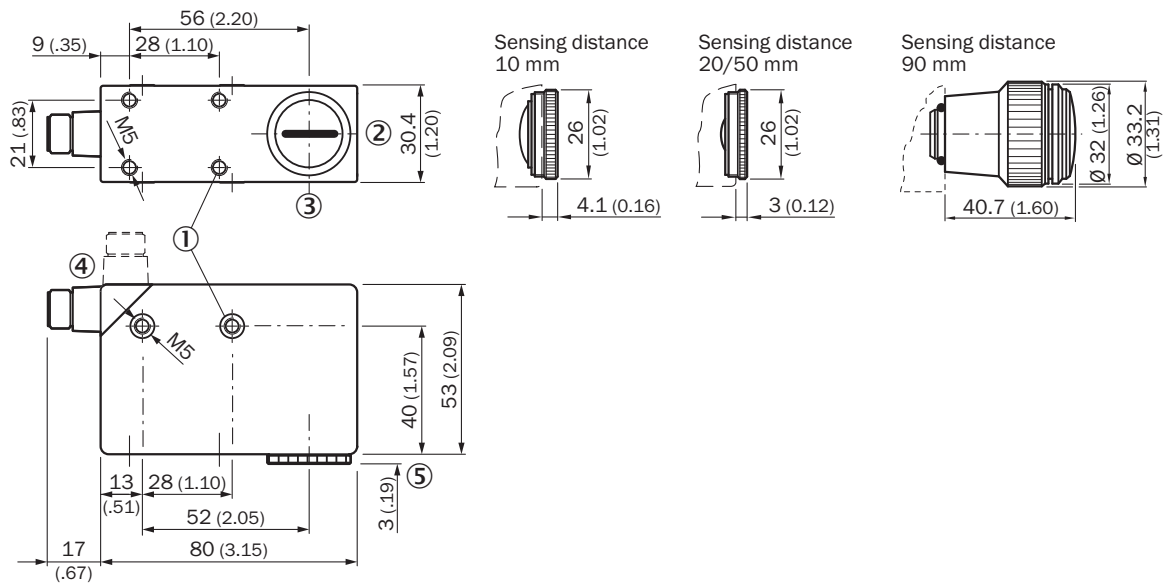

Dimensions in mm (inch)

- ① M5 threaded mounting hole, 5.5 mm deep
- ② Light spot direction
- ③ Center of optical axis
- ④ Connector M12 (rotatable up to 90°)
- ⑤ see dimensional drawings of lenses

### Pinouts

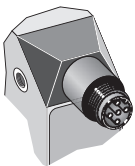

## Adjustments

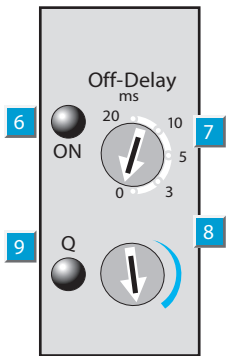

- ⑥ Operating indicator
- ⑦ time delay selector switch
- ⑧ sensitivity control
- ⑨ Output indicator

## Connection diagram

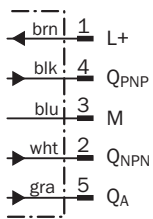



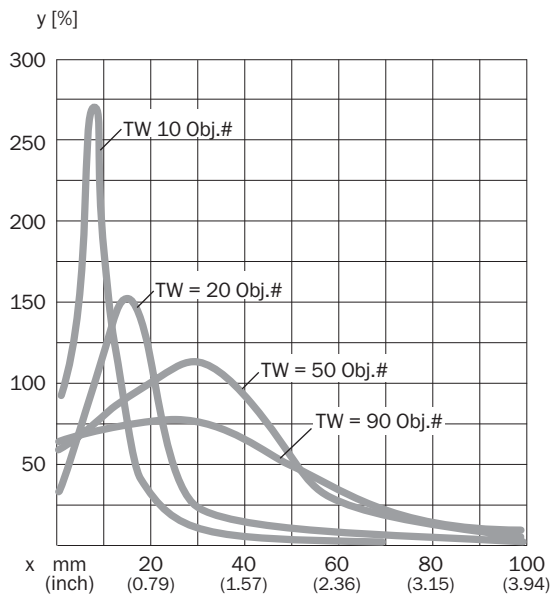

## Sensing distance



## Recommended accessories

Other models and accessories → [www.sick.com/LUT3](http://www.sick.com/LUT3)

	Brief description	Type	part no.
<b>Mounting systems</b>			
	<ul style="list-style-type: none"> <li><b>Description:</b> Plate G for universal clamp bracket</li> <li><b>Material:</b> Steel</li> <li><b>Details:</b> Steel, zinc coated</li> <li><b>Items supplied:</b> Universal clamp (2022726), mounting hardware</li> <li><b>Usable for:</b> W34, LUT3, KT5-2, KT10, CS8, W24-2, KT8, KT8</li> </ul>	BEF-KHS-G01	2022464
	<ul style="list-style-type: none"> <li><b>Description:</b> Plate K for universal clamp bracket</li> <li><b>Material:</b> Steel</li> <li><b>Details:</b> Steel, zinc coated</li> <li><b>Items supplied:</b> Universal clamp (2022726), mounting hardware</li> <li><b>Usable for:</b> W11-2, W12-3, W14-2, W18-3, W23-2, W24-2, W27-3, W30, W32, W34, W36, PL50A, PL80A, P250, UC12, LUT3, KT2, KT5-2, KT8, CS8, DT2, DS30, DS40, W12-2 Laser, W16, W26, KT5</li> </ul>	BEF-KHS-K01	2022718
<b>Commissioning aids and test equipment</b>			
	<ul style="list-style-type: none"> <li><b>Description:</b> Writing chalk, red fluorescence</li> </ul>	LUM-KLK	1002959
	<ul style="list-style-type: none"> <li><b>Description:</b> Thick chalk, red fluorescent, 12 units</li> </ul>	LUM-FT	1004460

## SICK AT A GLANCE

SICK is one of the leading manufacturers of intelligent sensors and sensor solutions for industrial applications. A unique range of products and services creates the perfect basis for controlling processes securely and efficiently, protecting individuals from accidents and preventing damage to the environment.

We have extensive experience in a wide range of industries and understand their processes and requirements. With intelligent sensors, we can deliver exactly what our customers need. In application centers in Europe, Asia and North America, system solutions are tested and optimized in accordance with customer specifications. All this makes us a reliable supplier and development partner.

Comprehensive services complete our offering: SICK LifeTime Services provide support throughout the machine life cycle and ensure safety and productivity.

For us, that is “Sensor Intelligence.”

## WORLDWIDE PRESENCE:

Contacts and other locations –[www.sick.com](http://www.sick.com)