



# WT12L-2B550

## W12

PHOTOELECTRIC SENSORS

**SICK**  
Sensor Intelligence.



Illustration may differ

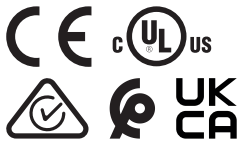

### Ordering information

Type	part no.
WT12L-2B550	1017904

**Included in delivery:** BEF-KH-W12 (1)

Other models and accessories → [www.sick.com/W12](http://www.sick.com/W12)

### Detailed technical data

#### Features

<b>Functional principle</b>	Photoelectric proximity sensor	
<b>Functional principle detail</b>	Background suppression	
<b>Sensing range max.</b>	30 mm ... 200 mm <sup>1)</sup>	
<b>Emitted beam</b>	Light source	Laser <sup>2)</sup>
	Type of light	Visible red light
	Light spot size (distance)	Ø 0.2 mm (100 mm)
<b>Focus position</b>	100 mm	
<b>Key laser figures</b>	Normative reference	EN 60825-1:2014, IEC 60825-1:2007
	Laser class	2 <sup>3) 4)</sup>
<b>Key LED figures</b>	Wave length	650 nm
<b>Adjustment</b>	Potentiometer	
<b>Special applications</b>	Detecting small objects, Detection of objects moving at high speeds	
<b>Items supplied</b>	2 x clamps BEF-KH-W12, incl. screws	

<sup>1)</sup> Object with 18% remission (based on standard white, DIN 5033).

<sup>2)</sup> Average service life: 50,000 h at T<sub>U</sub> = +25 °C.

<sup>3)</sup> Pulse length 4 µs, max. pulse power < 5,0 mW.

<sup>4)</sup> Do not intentionally look into the laser beam. Never point the laser beam at people's eyes.

#### Safety-related parameters

<b>MTTF<sub>D</sub></b>	316 years
<b>DC<sub>avg</sub></b>	0 %

## Electronics

<b>Supply voltage <math>U_B</math></b>	10 V DC ... 30 V DC <sup>1)</sup>	
<b>Ripple</b>	< 5 V <sub>pp</sub> <sup>2)</sup>	
<b>Current consumption</b>	55 mA <sup>3)</sup>	
<b>Protection class</b>	III	
<b>Digital output</b>	Type	
	PNP <sup>4)</sup>	
	NPN <sup>5)</sup>	
	Switching mode	Light switching, Dark switching <sup>4) 5)</sup>
	Switching mode selector	Selectable via L/D control cable
	Signal voltage PNP HIGH/LOW	U <sub>v</sub> - < 2 V, U <sub>v</sub> / 0 V, <= 1.5 V
	Signal voltage NPN HIGH/LOW	U <sub>v</sub> - < 2 V, U <sub>v</sub> / 0 V, <= 1.5 V
Output current I <sub>max.</sub>	≤ 100 mA	
Response time	≤ 200 μs <sup>6)</sup>	
Switching frequency	2,500 Hz <sup>7)</sup>	
<b>Circuit protection</b>	A <sup>8)</sup> C <sup>9)</sup> D <sup>10)</sup>	

<sup>1)</sup> Limit values when operated in short-circuit protected network: max. 8 A.

<sup>2)</sup> May not fall below or exceed U<sub>y</sub> tolerances.

<sup>3)</sup> Without load.

<sup>4)</sup> 0 V or not connected, light switching.

<sup>5)</sup> U<sub>v</sub>, dark switching.

<sup>6)</sup> Signal transit time with resistive load.

<sup>7)</sup> With light/dark ratio 1:1.

<sup>8)</sup> A = V<sub>S</sub> connections reverse-polarity protected.

<sup>9)</sup> C = interference suppression.

<sup>10)</sup> D = outputs overcurrent and short-circuit protected.

## Mechanics

<b>Housing</b>	Rectangular	
<b>Dimensions (W x H x D)</b>	15 mm x 49 mm x 41.5 mm	
<b>Connection</b>	Plug, M12, 5-pin	
<b>Material</b>	Housing	Metal
	Front screen	Plastic, PMMA
<b>Weight</b>	130 g	

## Ambient data

<b>Enclosure rating</b>	IP67 IP69K
<b>Ambient operating temperature</b>	-10 °C ... +50 °C
<b>Ambient temperature, storage</b>	-25 °C ... +75 °C
<b>UL File No.</b>	NRKH.E181493 & NRKH7.E181493

Certificates

<b>EU declaration of conformity</b>	✓
<b>UK declaration of conformity</b>	✓
<b>ACMA declaration of conformity</b>	✓
<b>Moroccan declaration of conformity</b>	✓
<b>China RoHS</b>	✓
<b>cULus certificate</b>	✓
<b>Laser safety (IEC 60825-1) certificate</b>	✓

Classifications

<b>ECLASS 5.0</b>	27270904
<b>ECLASS 5.1.4</b>	27270904
<b>ECLASS 6.0</b>	27270904
<b>ECLASS 6.2</b>	27270904
<b>ECLASS 7.0</b>	27270904
<b>ECLASS 8.0</b>	27270904
<b>ECLASS 8.1</b>	27270904
<b>ECLASS 9.0</b>	27270904
<b>ECLASS 10.0</b>	27270904
<b>ECLASS 11.0</b>	27270904
<b>ECLASS 12.0</b>	27270903
<b>ETIM 5.0</b>	EC002719
<b>ETIM 6.0</b>	EC002719
<b>ETIM 7.0</b>	EC002719
<b>ETIM 8.0</b>	EC002719
<b>UNSPSC 16.0901</b>	39121528

Dimensional drawing WT12L-2

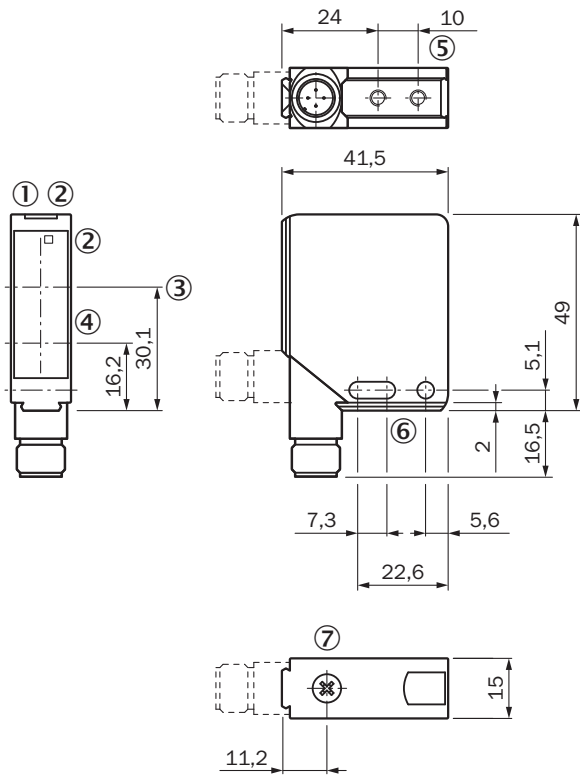

Dimensions in mm (inch)

- ① Operating indicator, green
- ② LED reception indicator, yellow
- ③ Optical axis, receiver
- ④ Optical axis, sender
- ⑤ M4 threaded mounting hole – 4 mm depth
- ⑥ Mounting hole, Ø 4.2 mm
- ⑦ Adjustment of sensing range

Adjustments WT12L-2

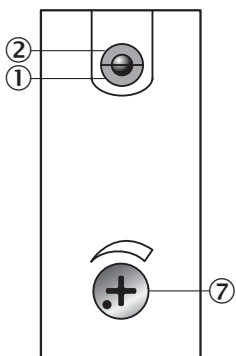

- ① Operating indicator, green
- ② LED reception indicator, yellow
- ⑦ Adjustment of sensing range

Connection type

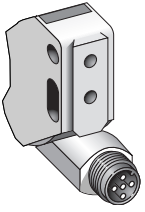

Connection diagram Cd-145

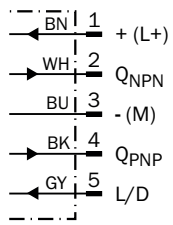

Characteristic curve WT12L-2

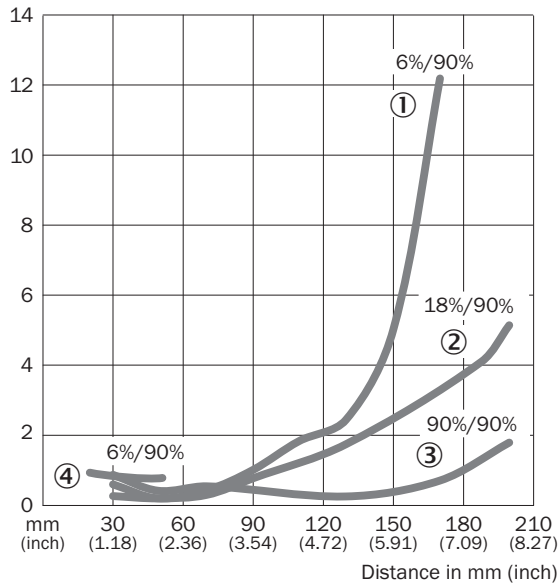

- ① Sensing range on black, 6% remission factor
- ② Sensing range on gray, 18% remission factor
- ③ Sensing range on white, 90% remission factor
- ④ Sensing range on black, 6 % remission, fix

Light spot size WT12L-2

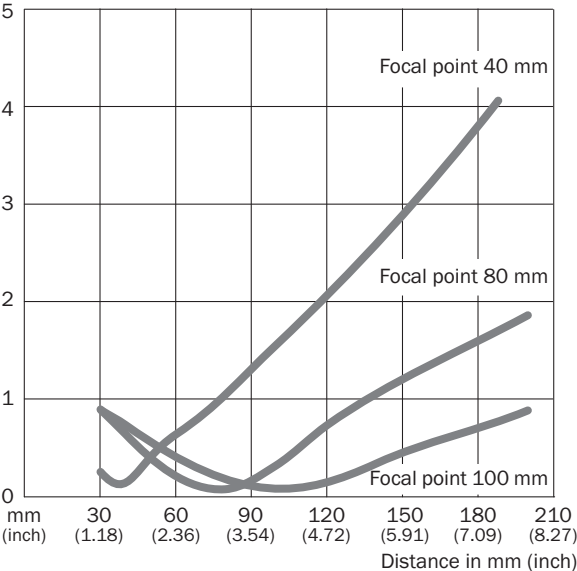

Sensing range diagram WT12L-2

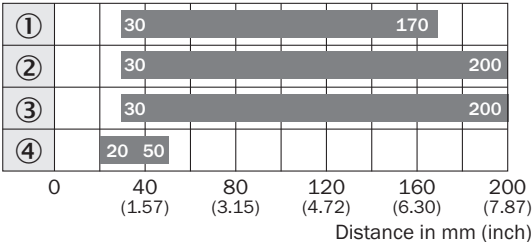



- Sensing range
- ① Sensing range on black, 6% remission factor
- ② Sensing range on gray, 18% remission factor
- ③ Sensing range on white, 90% remission factor
- ④ Sensing range on black, 6% remission, fix

Recommended accessories

Other models and accessories → [www.sick.com/W12](http://www.sick.com/W12)

	Brief description	Type	part no.
Mounting systems			
	<ul style="list-style-type: none"> <li>• <b>Description:</b> Mounting bracket, large</li> <li>• <b>Material:</b> Stainless steel</li> <li>• <b>Details:</b> Stainless steel</li> <li>• <b>Items supplied:</b> Mounting hardware included</li> <li>• <b>Suitable for:</b> W11-2, W12-3, W16</li> </ul>	BEF-WG-W12	2013942

	Brief description	Type	part no.
connectors and cables			
	<ul style="list-style-type: none"> <li>• <b>Connection type head A:</b> Female connector, M12, 5-pin, straight, A-coded</li> <li>• <b>Connection type head B:</b> Flying leads</li> <li>• <b>Signal type:</b> Sensor/actuator cable</li> <li>• <b>Cable:</b> 5 m, 5-wire, PUR, halogen-free</li> <li>• <b>Description:</b> Sensor/actuator cable, unshielded</li> <li>• <b>Application:</b> Drag chain operation, Zones with oils and lubricants, Robot, Drag chain operation</li> </ul>	YF2A15-050UB5XLEAX	2095618
	<ul style="list-style-type: none"> <li>• <b>Connection type head A:</b> Female connector, M12, 5-pin, straight, A-coded</li> <li>• <b>Connection type head B:</b> Flying leads</li> <li>• <b>Signal type:</b> Sensor/actuator cable</li> <li>• <b>Cable:</b> 5 m, 5-wire, PVC</li> <li>• <b>Description:</b> Sensor/actuator cable, unshielded</li> <li>• <b>Application:</b> Uncontaminated zones, Zones with chemicals</li> </ul>	YF2A15-050VB5XLEAX	2096240



## SICK AT A GLANCE

SICK is one of the leading manufacturers of intelligent sensors and sensor solutions for industrial applications. A unique range of products and services creates the perfect basis for controlling processes securely and efficiently, protecting individuals from accidents and preventing damage to the environment.

We have extensive experience in a wide range of industries and understand their processes and requirements. With intelligent sensors, we can deliver exactly what our customers need. In application centers in Europe, Asia and North America, system solutions are tested and optimized in accordance with customer specifications. All this makes us a reliable supplier and development partner.

Comprehensive services complete our offering: SICK LifeTime Services provide support throughout the machine life cycle and ensure safety and productivity.

For us, that is “Sensor Intelligence.”

## WORLDWIDE PRESENCE:

Contacts and other locations –[www.sick.com](http://www.sick.com)